



Smart-Vue Pro Duo/Quatro

User Guide

331676H05 • Revision C • 1/17/2022

IMPORTANT Read this instruction manual. Failure to follow the instructions in this manual can result in damage to the unit, injury to operating personnel, and poor equipment performance.

CAUTION All internal adjustments and maintenance must be performed by qualified service personnel.

Material in this manual is for informational purposes only. The contents and the product it describes are subject to change without notice. Thermo Fisher Scientific makes no representations or warranties with respect to this manual. In no event shall Thermo be held liable for any damages, direct or incidental, arising from or related to the use of this manual.

© 2022 Thermo Fisher Scientific Inc. All rights reserved.

Contents

Models	1
Safety Notices	2
Device Maintenance	3
Regulatory Information	4
Certifications and Compliance	4
Introduction	6
About this User Guide	6
Intended Use	7
Smart-Vue Pro Solution Overview	7
Hardware Overview	10
Package Contents	12
Technical Specifications	13
Characteristics	13
Dimensions	15
Power Options	16
Getting Started	17
Prerequisites for Getting Started	17
Attach Antenna	17
Activating the Smart-Vue Pro Duo/Quatro Data Logger for LoRaWAN	17
Installing the Smart-Vue Pro Duo/Quatro Data Logger	20
Optimizing Wireless Performance	20
Preparing the Mounting Kit	20

Using External Sensors	22
Pt100 Smart-Sensors	22
Digital Temperature Sensors	24
Temperature/Humidity Smart-Sensors™	26
Dry Contact Input Sensor	26
4-20 mA and 0-5 V Loop Sensors	30
Smart-View Pro Duo / Quatro User Interface	31
Using the Touchscreen	31
Entering your PIN Code	31
Sensor Display and Control	32
Screen Backlight	35
Screen Saver	35
Configuration Menus	36
Settings	39
Sensors	41
Advanced Menu	42
LoRaWAN Radio Performance	44
Quick Server Connection Test	44
Data Synchronization	45
Using the Data Logger in Bluetooth-only Mode	45
Alarm Management	46
LED Status Indications	46
Alarm Actions	47
Maintaining your Data Loggers	49
Replacing Batteries	49
Cleaning Instructions	50

Appendix 1 – Smart-Vue Pro Duo/Quatro	
Battery Life	51
Estimated Battery Life	51
Appendix 2 - Troubleshooting	52
WEEE Compliance	53
Contact Information	54

Models

Models in the below table shows the modules covered in this manual.

Note: Smart-Vue Pro Duo/Quatro below part numbers transition shall be effective from 20 December 2021.

Table 1. Transition Part Number Details

Initial Part Number	Initial Part Number Description	New Part Number	New Part Number Description (915MHz – US, 868MHz-EU)
SVPHWRMOD002	Smart-Vue Pro Duo	SVPHWRMOD012	Smart-Vue Pro Duo 915MHz
SVPHWRMOD002	Smart-Vue Pro Duo	SVPHWRMOD022	Smart-Vue Pro Duo 868MHz
SVPHWRMOD004	Smart-Vue Pro Quatro	SVPHWRMOD014	Smart-Vue Pro Quatro 915MHz
SVPHWRMOD004	Smart-Vue Pro Quatro	SVPHWRMOD024	Smart-Vue Pro Quatro 868MHz

Safety Notices

IMPORTANT NOTE: Do not use this product for protection or as part of an automated emergency system or as for any other application that involves protecting people and/or property. This product is designed for use in environments where children are not likely to be present. Customers and users of Thermo Scientific products are responsible for making sure that the product is fit for the intended usage. Do not open the product casing and do not disassemble or modify internal components in any manner. Thermo Scientific products do not contain any internal components that require user intervention or repair. If the device shows signs of improper operation, disconnect it immediately from its power source or remove the battery and contact Thermo Scientific technical services.



Electrical Warning

CAUTION: To reduce the risk of electric shock, do not open or remove the product casing. No user-serviceable parts inside. Refer servicing to qualified service personnel.

The lightning flash with arrowhead symbol is intended to alert the user to the presence of uninsulated “dangerous voltage” within the product’s enclosure that may be of sufficient magnitude to constitute a risk of electric shock to a person.



Battery Warning

CAUTION: This product contains two non-rechargeable 3.6V lithium batteries. Plugging the device into the AC adapter (USB) does not recharge the batteries. Ensure you respect polarity (+/-) as indicated inside the battery compartment while inserting batteries into Thermo Scientific devices. Reversing polarity by inserting the batteries incorrectly can cause the product to heat up and may lead to battery liquid leakage. Use only batteries recommended by Thermo Scientific. Do not use a different type of battery such as rechargeable, alkaline and magnesium or use batteries of different brands or even different types of batteries of the same brand. Never dispose of batteries in fire. Do not charge regular batteries that are not specifically rechargeable. When the battery is low or in case the battery-operated device in question remains unused for a lengthy period of time remove the battery from the device in order to avoid any risk of battery liquid leakage. Never leave batteries within the reach of children. In case of a battery leak, avoid all contact with the liquid present on the batteries. Rinse with clear water immediately in case the battery liquid comes into contact with the eyes, mouth or skin. Contact a doctor or emergency service immediately. Battery liquid is corrosive and can damage vision or cause blindness or chemical burns.

Device Maintenance

When maintaining your device:



CAUTION: Do not attempt to disassemble the device. There are no user serviceable parts inside.



CAUTION: Do not misuse the device. Follow instructions on proper operation and only use as intended. Misuse could make the device inoperable, damage the device and/or other equipment or harm users.



CAUTION: Do not apply excessive pressure or place unnecessary weight on the device. This could result in damage to the device or harm to users.



CAUTION: Do not use this device in explosive or hazardous environments.



CAUTION: Do not expose your device to any extreme environment where the temperature or humidity is high. Such exposure could result in damage to the device or fire.



CAUTION: Do not expose the device to water, rain, or spilled beverages. It is not waterproof. Exposure to liquids could result in damage to the device.



CAUTION: Do not place the device alongside computer discs, credit or travel cards or other magnetic media. The information contained on discs or cards may be affected by the device.



CAUTION: Using accessories, such as antennas, that Thermofisher has not authorized or that are not compliant with Thermofisher accessory specifications may invalidate the warranty.

Regulatory Information

Certifications and Compliance



This paragraph pertains to 915 MHz Smart-Vue Pro™ wireless devices. This device complies with part 15 of the FCC rules.

Operation is subject to the following two conditions.

1. This device may not cause harmful interference.
2. This device must accept any interference received, including interference that may cause undesired operation.

FCC RF Radiation Exposure Statement

This equipment complies with FCC radiation exposure limits set forth for an uncontrolled environment. In order to avoid the possibility of exceeding the FCC radio frequency exposure limits, human proximity to the antenna should not be less than 20 cm (8 inches) during normal operation. End users must follow the specific operating instructions for satisfying RF exposure compliance. This transmitter must not be co-located or operating in conjunction with any other antenna or transmitter.

47 CFR Part 15 Regulation Class B Devices

Note: This Equipment has been tested and found to comply with the limits for a Class B digital device, pursuant to part 15 of the FCC Rules.

These limits are designed to provide reasonable protection against harmful interference in a residential installation. This equipment generates, uses and can radiate radio frequency energy if not installed and used in accordance with the instructions, may cause harmful interference to radio communications. However, there is no guarantee that interference will not occur in a particular installation. If this equipment does cause harmful interference to radio or television reception which can be determined by turning the equipment off and on, the user is encouraged to try to correct the interference by one or more of the following measures:

1. Reorient or relocate the receiving antenna.
2. Increase the separation between the equipment and receiver.

3. Connect the equipment into an outlet on a circuit different from that to which the receiver is connected.
4. Consult the dealer or an experienced radio/TV technician for help.



This paragraph pertains to 915 MHz Smart-Vue Pro wireless devices. This device complies with Industry Canada license-exempt RSS standard(s). Operation is subject to the following two conditions:

1. This device may not cause interference, and
2. This device must accept any interference, including interference that may cause undesired operation of the device.

Under Industry Canada regulations, this radio transmitter may only operate using an antenna of a type and maximum (or lesser) gain approved for the transmitter by Industry Canada. To reduce potential radio interference to other users, the antenna type and its gain should be so chosen that the equivalent isotropically radiated power (e.i.r.p.) is not more than that necessary for successful communication.

CE - Conformity with European regulations

This paragraph pertains to 868 MHz Smart-Vue Pro™ wireless devices. The Thermo Scientific product is compliant with the essential requirements and other relevant requirements of the following standards and/or normative documents.

- Directives:
 - 2014/53/EU Radio Equipment Directive (RED)
 - 2014/30/EU EMC Directive
 - 2014/35/EU Low Voltage Directive
 - 2011/65/EU and the amendment of (EU) 2015/863 Restriction of Hazardous Substances Directive.
- In application of the following standards
 - ETSI EN 300 220-2 V3.1.1
 - EN 301 489-1 V2. 2.3
 - EN 301 489-3: V2.1.1
 - EN 301 489-17 V3. 2.4
 - EN 300 328 V2. 2.2
 - CAN/CSA-C22.2 No. 61010-1-12/A1:2018-11
UL 61010-1:2012/R:2019-07
 - EN 61010-1:2010/A1:2019
IEC 61010-1:2010/A1:2016
 - EN 61326-1:2013



CAUTION: Any changes or modifications not expressly approved by Thermo Scientific could void the user's authority to operate the equipment.



The wireless device is in compliance with the EU Directive 2011/65/EU (Restriction of the Use of Certain Hazardous Substances in Electronic and Electrical Equipment) and the amendment of (EU) 2015/863. Do not dispose of this product with household trash. Thermo Scientific recycles this product under certain conditions. Contact us for more information.

Introduction

Smart-Vue Pro Duo/Quatro is the new generation of wireless data logger by Thermo Scientific.

This user guide presents an overview of Smart-Vue Pro followed by instructions to get your data logger(s) up and running quickly. The focus of this document is mainly on physical/hardware aspects of the data logger.

The configuration instructions and software settings are provided in detail in related documentation for Smart-Vue Pro companion software applications and hardware:

- **Smart-Vue Pro**, a Thermo Scientific web application offering a complete sensor programming and monitoring interface.
- **LoRaWAN-enabled receiver**, a very long range wireless communication protocol for communicating with smart-vue pro data loggers.
- **Smart Connect**, a Thermo Scientific Smart Connect mobile application for managing Smart-Vue Pro Duo/Quatro data loggers in bluetooth mode.

About this User Guide

Terminology

The following are the terms and references used in this user guide:

Alarm: An alarm is a state which occurs when the system observes a sensor reading that is outside programmed range limits such as, a temperature reading that is too high or too low. When an alarm occurs, the system notifies you by sending an alert.

Alert: An alert is a notification sent by the system to you when the system observes an alarm condition or a potential problem.

Bluetooth™: Short-range wireless communication protocol generally used in point-to-point connections (i.e., between a smart-phone and a data logger). Wireless range with bluetooth smart reaches up to about 100 feet (~30 meters).

Dry Contact Input: Binary state detection, also known as “open/closed” detection.

Smart-Vue Pro LoRaWAN: Very-long-range wireless communication protocol generally with one single receiver installed per site. Line-of-sight range up to nearly 10 miles (16 km).

Data logger: Refers to Smart-Vue Pro Duo/Quatro device.

Equipment: Refers to the equipment or space (such as a refrigerator, freezer, incubator or cold room) which monitors one or more physical parameters.

Smart Connect: Thermo Scientific Smart Connect mobile application for bluetooth-enabled smart-phones and tablets. Used with Smart-Vue Pro Duo/Quatro in bluetooth mode.

Web platform: Internet-based service in which data from data loggers is stored and accessed via the Smart-Vue Pro application.

Smart-Vue Alert: Smart-Vue alert is a subscription license for an international internet-based platform that delivers alerts to cellular phones via SMS/text messages and voice calls.

Smart-Vue Pro: A web application that allows you to configure, manage and monitor Smart-Vue Pro Duo/Quatro data loggers.

Differentiating Smart-Vue Pro LoRaWAN vs Bluetooth Features in this Guide

Smart-Vue Pro Duo/Quatro data logger can be used with either Smart-Vue Pro LoRaWAN or bluetooth wireless connectivity. Some product features described in this user guide may differ according to the technology used. Specific differences are given in the following table with comments regarding each technology option.



Note: Comments for Smart-Vue Pro LoRaWAN operation are shown next to the Smart-Vue Pro LoRaWAN logo.



Note: Comments for bluetooth operation are shown next to the bluetooth logo.

Intended Use

The Smart-Vue Pro Duo/Quatro data logger (module) is intended to monitor and record a range of physical parameters such as temperature, humidity, 4-20mA depending on the sensors connected to it. The data logger supports digital and PT100 sensors, 4-20mA sensors. The information collected using the sensors can then be transmitted to a database server or cloud using a very-long-range or short-range wireless communication protocols like LoRaWAN or Bluetooth wireless connectivity respectively. The data can be accessed via a mobile application (Smart Connect) or via a web application (Smart-Vue Pro), additionally, Smart Connect permits the user to push the data to the cloud. The Smart-Vue Pro Duo/Quatro data logger and the Smart-Vue Pro Web application enables the user to manage the entire Smart-Vue Pro solutions. The system can also support audio and visual signaling devices such as Smart Remote Contact (module) and Smart Siren (module). Refer to the user guides of these modules for more information.

The Smart-Vue Pro Solutions is intended to monitor and record critical physical parameters in life science, pharmaceutical, and agri-food sectors and perfect for monitoring several pieces of equipment simultaneously that are used in a typical laboratory or in a storage facility. These products should only be used by authorized and adequately trained personnel. It is not considered as a medical device or accessory to a medical device and has therefore not been registered with a medical device regulatory agency. The Smart-Vue Pro Solutions is 21CFRPart11 compatible system and can be used as a document management system in a regulated environment, when the entire solution is controlled through the web application (Smart-Vue Pro). It is the user's responsibility to develop verification and validation protocol based on the record keeping requirements.

Smart-Vue Pro Solution Overview

Smart-Vue Pro Duo/Quatro data loggers monitor temperature, humidity and other physical parameters which are critical in life science, pharmaceutical and agricultural food sectors. Smart-Vue Pro provides a flexible solution for monitoring parameters simultaneously on several pieces of equipment in lab or storage facilities.

LoRaWAN vs Bluetooth Wireless Topologies

Supporting both bluetooth and LoRaWAN wireless technologies, Smart-Vue Pro Duo/Quatro offers two distinct wireless connectivity models to cover one's need.

Smart-Vue Pro LoRaWAN

Smart-Vue Pro LoRaWAN is a long-range wireless technology (with range up to 10 mi./16 km).

The architecture is based on a "star" topology in which wireless data loggers connect to a gateway communicating bi-directionally with a server that collects and analyzes information collected by sensors (either on the cloud or on-premises server).

Smart-Vue Pro LoRaWAN's long range connectivity simplifies installations on geographically large sites where a single receiver is often sufficient to cover entire complexes and campuses.

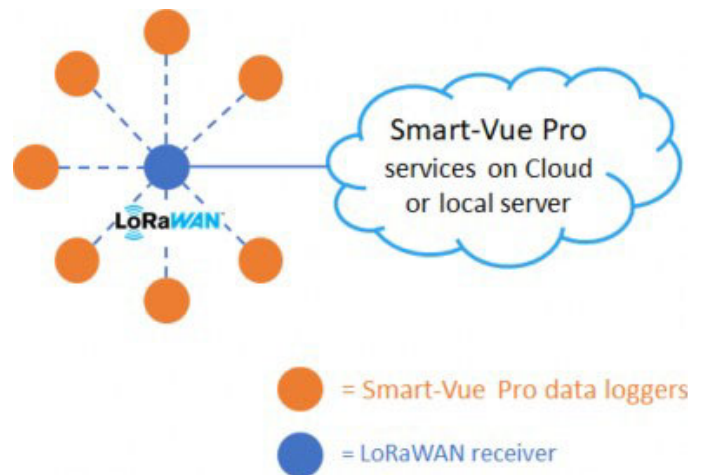

Figure 1. Smart-Vue Pro Duo/Quatro data loggers in Smart-Vue Pro LoRaWAN mode communicate with a receiver that is connected to the Smart-Vue Pro web platform

Bluetooth

Bluetooth is a shorter-range wireless technology (with range up to about 100 feet/30 m) commonly found in Smart Connect mobile devices such as smart-phones and tablets. Bluetooth architecture is generally based on a “point-to-point” connection between two devices such as a Smart-Vue Pro Duo/Quatro data logger and a smart-phone.

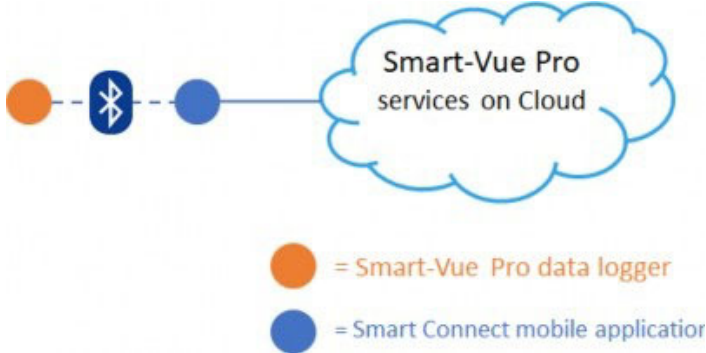

Figure 2. Smart-Vue Pro Duo/Quatro data logger in Bluetooth mode with point-to-point connection to smart-phone or tablet running Smart Connect mobile application

Smart-Vue Pro Duo/Quatro Data Logger Features

Monitoring

- Multi-parameter sensor monitoring with support for a variety of smart-sensors, digital and Pt100 sensors and 4-20mA sensors.
- The Smart Connect mobile app supports monitoring of a single temperature sensor.
- Automatic recognition of connected sensors.
- Configurable high/low alarm limits, delays, alerts and transmission interval.
- Calibration parameters embedded directly in Thermo Scientific Smart-Sensors (for ease-of-use and standard exchange for periodic calibration) with parameters downloaded automatically.
- Unlimited data storage with Smart-Vue Pro web architecture.
- Internal data logger memory for upto 4,000 readings per channel (8,000 total on Smart-Vue Pro Duo; 16,000 total on Smart-Vue Pro Quatro).
- Alarm transmission upon detection.
- ISO 17025 (COFRAC) calibration, in-house certified laboratory calibration or NIST traceable calibration.

Connectivity

- Wireless connectivity with Smart-Vue Pro LoRaWAN (long-range, low-power wireless connectivity or Bluetooth Low Energy (shorter range).
- Automatic wireless connection to Smart-Vue Pro LoRaWAN enabled receiver.

Device Details

- 2.4-inch color resistive LCD touch screen (supports operation with gloves).
- Runs on two LS17500 batteries or optional 5 V USB adapter.
- Integrated alarm buzzer for real-time alerts on-site.
- Clear plastic outer ring lights to provide visual alert.
- Dry contact input (available as of firmware version 2.6.x).

Information Flow

The following diagram summarizes the Smart-Vue Pro Duo/Quatro information flow. Note that Smart-Vue Pro Duo/Quatro data loggers can be used with either Smart-Vue Pro LoRaWAN or Bluetooth wireless connectivity.

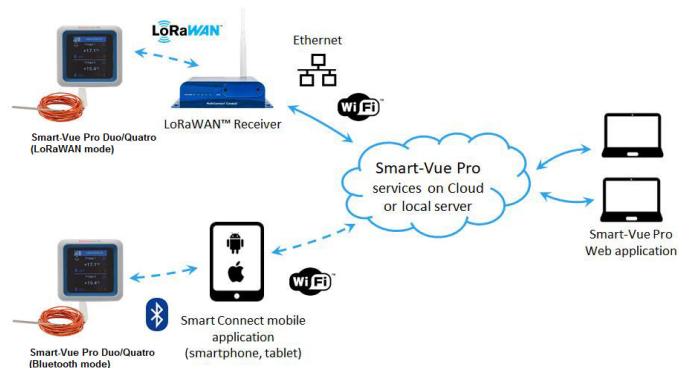

Figure 3. Smart-Vue Pro Duo/Quatro data loggers communicate with the Web platform either via a LoRaWAN receiver or a Bluetooth smart-phone, tablet

Table 2. Smart-Vue Pro LoRaWAN Operation

Step	Process	Comments
1	Place your Smart-Vue Pro Duo/Quatro data logger appropriately to monitor your equipment.	For best wireless performance, follow recommendations when physically placing your device, (Installing the Smart-Vue Pro Duo/Quatro Data Logger).
2	Plug in wired sensors (which are recognized automatically) and/or pair Bluetooth sensors (for future). Use the data logger's touch screen to connect wirelessly to your on-premises LoRaWAN™ receiver or a public network.	
3	Login to the Smart-Vue Pro Duo/Quatro web application. Set up the data logger and configure data logging settings such as upper and lower limit values. Push the configuration to your Smart-Vue Pro Duo/Quatro data logger. The data logger is updated and data logging begins.	The Smart-Vue Pro web application authenticates users, configures alarm settings, programs data logging, analyses data, generates reports.
4	The data logger collects data from its sensors and transfers the information wirelessly to the Smart-Vue Pro LoRaWAN network.	Installed at your site, LoRaWAN receiver transmits locally collected sensor data via the internet to the web platform or your server as programmed.
5	Uploaded data logging details are visible on smart-vuepro.thermoscientific.com	You may use computers with web browser to access readings and alarms.

Table 3. Bluetooth-only Operation

Step	Process	Comments
1	Place the Smart-Vue Pro Duo/Quatro data logger appropriately to monitor your equipment.	Note: Bluetooth connectivity is limited to about 30 meters indoors. Keep the data logger in an area that is as unobstructed as possible.
2	Plug in wired sensor (which are recognized automatically). Note: You may plug only one sensor into a Smart-Vue Pro Duo/Quatro data logger in bluetooth mode. Use the data loggers touch screen to deactivate Smart-Vue Pro LoRaWAN connectivity (Menu →Advanced →[PIN code] →OK →LoRaWAN →On/Off →Off →Save).	Bluetooth remains active when you deactivate LoRaWAN functionality.
3	Login to Smart-Vue Pro Duo/Quatro web application. Create the Smart-Vue Pro Duo/Quatro data logger. Use the Smart Connect to configure data logging settings such as upper and lower limit values.	All data logger configuration is handled using the Thermo Scientific Smart Connect mobile application.

Table 3. Bluetooth-only Operation

Step	Process	Comments
4	The data logger collects data from its sensors. Data is stored until you access it with either your smart-phone or tablet (which can push it to the web platform).	Your smart-phone or tablet will transmit locally collected sensor data via the internet to the web platform.
5	Uploaded data logging details are visible on smart-vuepro.thermoscientific.com.	

Hardware Overview

Front View

The front of the Smart-Vue Pro Duo/Quatro data logger is comprised of two user interface elements, the touch screen LCD and the clear plastic LED status ring around the casing. The touch screen shows data collected by the sensor(s) and gives you access to the setup menus. The status LED provides visual indications of the data logger status. For LED color indications, see **LED Status Indications**.

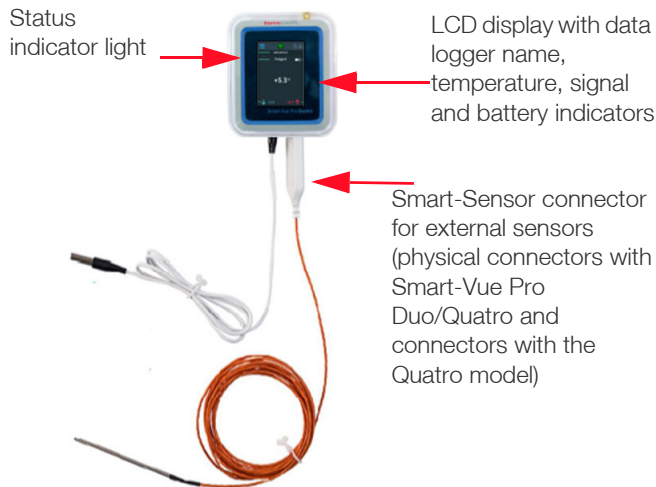

Figure 4. Smart-Vue Pro Duo/Quatro data logger with two external sensors

Rear View

The battery compartment is located behind the device. See **Activating the Smart-Vue Pro Duo/Quatro Data Logger for LoRaWAN** for instructions on inserting the provided batteries. The rear view of the device has a slot to attach the data logger to the plastic holder using the padlock (optional).

See **Installing the Smart-Vue Pro Duo/Quatro Data Logger** to check procedure of mounting the device.



Figure 5. Rear view of the data logger

Side View

The right side of the Smart-Vue Pro Duo/Quatro data logger features a USB port to power your data logger using the 5 V micro USB adapter (provided).



Figure 6. Side view of the Smart-Vue Pro Duo/Quatro data logger

Bottom View

The Smart-Vue Pro Duo/Quatro data loggers supports a combination of wired sensors.

- Up to 4 parameters on Smart-Vue Pro Quatro.
- Up to 2 parameters with Smart-Vue Pro Duo.

Plugs for connecting wired sensors are located at the bottom of the unit (two physical connectors on the Quatro model and one physical connector on the duo model). The plugs support single and dual sensor probes.

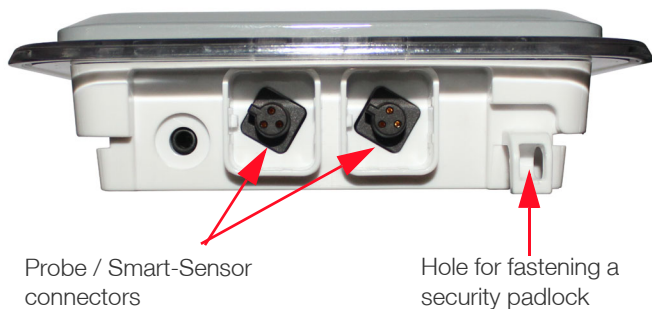

Figure 7. Bottom view of the Smart-Vue Pro Quatro data logger (with two physical connectors)

Compatible Sensor Types

Smart-Vue Pro Duo/Quatro data loggers supports a range of Thermo Fisher external digital temperature sensors and smart-sensors.

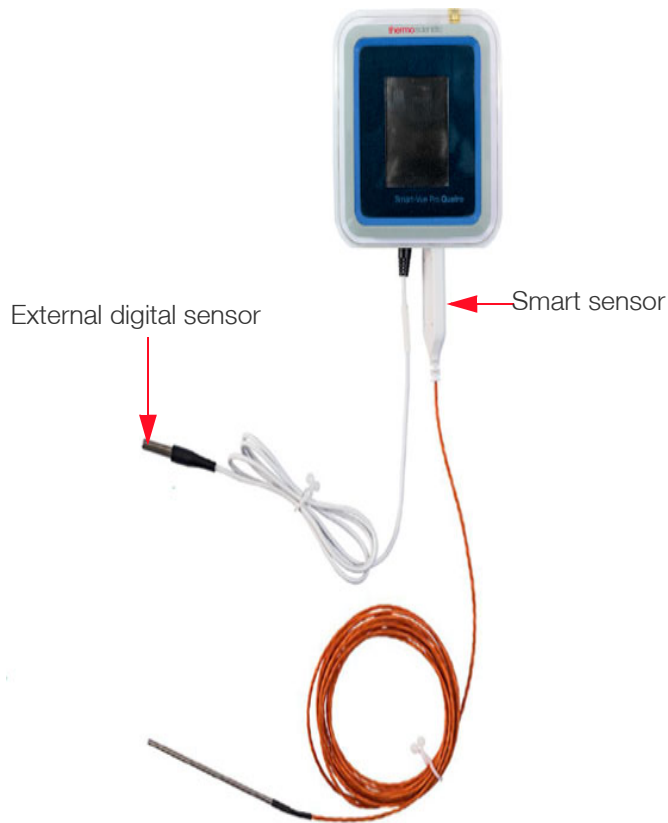

Figure 8. Example of Smart-Vue Pro Duo/Quatro data logger with two wired sensors

Each Smart-Vue Pro Duo/Quatro connector can be configured individually for supported sensor types. Consult with your authorized Smart-Vue representative for the latest product information.

Note: Compatible Sensors for Smart-Vue Pro Duo / Quatro Data Logger are

- Emerald Wireless Remote Sensor
- Triple - CO₂, Temperature and Humidity Sensor
- Differential Pressure Sensor
- Pt100 adapters

Refer Supplemental User guide 331942H01 for more details.

Package Contents

- One Smart-View Pro Duo/Quatro wireless data logger with antenna.
- Two 3.6 V LS17500 batteries (with additional screw for battery cover).
- One data logger mounting kit with magnetic holder and screws.
- 2 x 1.5 m (about 5 feet) flat sensor extension cables, sensor ties and hooks.

Optional

- 5 V AC/DC adapter with micro USB cable.
- Padlock to lock the data logger onto its holder for security.
- One calibration certificate per sensor (if purchased with calibration option).
- Round cable / flat ribbon cable for external digital temperature sensor.

Technical Specifications

Characteristics

General

- Color LCD display: 2.4 inches
- Touch screen: Resistive
- Number of sensor channels (simultaneous data logging sessions): Smart-Vue Pro Duo: 2 channels, Smart-Vue Pro Quatro: 4 channels.
- Number of sensors:
Smart-Vue Pro Duo/Quatro: One physical plug (supports 1 single, dual or triple sensor).
Smart-Vue Pro Quatro: Two physical plugs (supports 2 single, dual or triple sensors).

Note: It is important to distinguish between the number of sensors assigned to a given data logger and the number of simultaneous data logging sessions you can have.

- Audible alarms: Buzzer
- Power Supply: Batteries or micro-USB (5 V)

Note: The AC power adapter is provided separately and has: 5 V DC/1.2A. Batteries must be replaced by authorized technicians only.

Wireless Technologies

- LoRaWAN wireless connectivity for data transmission:
 - Range: approximately 16 km (about 10 miles) in line-of-sight.
 - Frequency (worldwide): 868 MHz (EU) or 915 MHz (USA).
 - Max power output: 14 dB (EU) or 20 dB (USA).
- Bluetooth Low Energy (BLE, also referred to as Bluetooth Smart) technology for use with Smart Connect mobile application:
 - Range: Up to about 50 meters (160 ft.) in line-of-sight.
 - Frequency: 2.4 GHz (worldwide).

Monitoring

- Read interval with Bluetooth operation: 5 seconds minimum on Smart-Vue Pro Duo or 15 seconds minimum on Smart-Vue Pro Quatro, up to 12 hours maximum.
- Read interval with LoRaWAN operation: 1 minute to 12 hours (depending on the transfer interval configured in the Smart-Vue Pro web application).
- Data storage:
 - Unlimited on Smart-Vue Pro web platform.
 - 4,000 readings (per sensor channel) stored in internal data logger memory.
- 1, 2 or 4 sensor tiles displayed simultaneously.
- Color LED indicator for alarm status or bluetooth communication.

Operating and Storage Conditions

- Indoor use only in non-harsh environments with mounting height under 2 meters (about 6.5 feet) from the floor.
- Data logger operating range: 0 °C to + 50 °C and 0 to 90% RH (non-condensing).
- Data logger storage conditions: -10°C to + 60 °C (14 °F and 140 °F); 0 to 99.99% relative humidity non-condensing.
- Pollution degree: 2 (normally only non-conductive pollution is supported; temporary conductivity caused by condensation is to be expected).

Casing & Dimensions

- Product protection: Designed for indoor use.
- Casing: ABS plastic
- Weight: 180 g (6.4 oz.) with batteries
- Dimensions: 100.8 x 110.8 x 296 mm (4 x 4.4 x 1.1 inches).
- Mounting:
 - Magnet (for use on metallic, non-painted surfaces).
 - Screw mount (optional locking with padlock). In this case, use two appropriate screws in compliance with regulatory requirements and safety practices.

Dimensions

Data Logger (in mm)

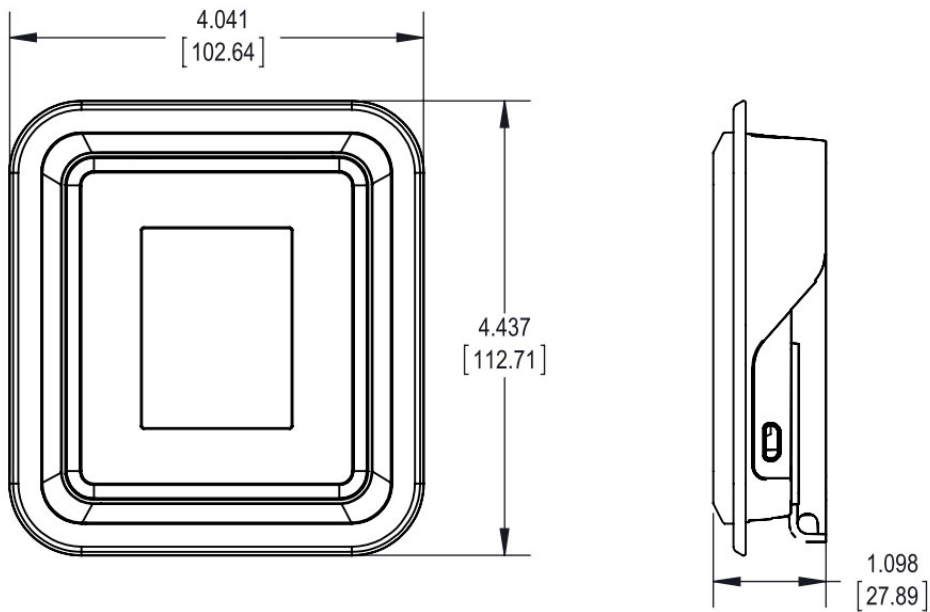

Figure 9. Smart-Vue Pro Duo/Quatro data logger dimensions

Mounting Kit

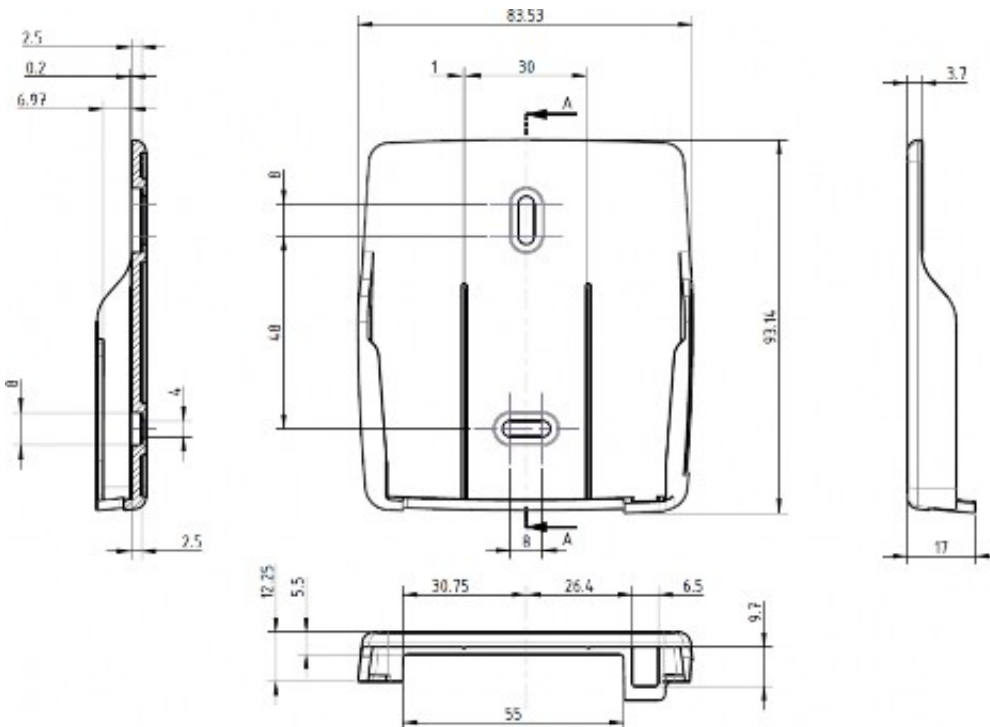

Figure 10. Smart-Vue Pro Duo/Quatro mounting kit details

Power Options

The Smart-Vue Pro Duo/Quatro data logger can be powered by two replaceable internal batteries (3.6 V) located behind your device or by AC power using the provided 5 V DC adapter.

Battery Characteristics

- 2 x SAFT LS17500 batteries: Lithium thionyl chloride A-size bobbin cell.
- Nominal voltage: 3.6 V
- Nominal capacity: 3600 mAh
- User-replaceable: Yes
- Battery life: Up to 2 years depending on usage. See **Maintaining your Data Loggers** for battery replacement instructions.

AC Adapter (Optional)

- Input: 100 – 240 V AC (auto-switching)
- Output: 5 V – 1.2 A
- Cable: Micro USB

Optimized power management enables your Smart-Vue Pro Duo/Quatro data logger to switch automatically to battery operation in the event of a power outage.



CAUTION: Use appropriate AC power supply in compliance with regulatory requirements and safety practices and also meet LPS requirements.



CAUTION: If plugged into AC power, the Smart-Vue Pro Duo/Quatro data logger will switch automatically to battery operation in the event of a power outage.

In such a case, an alert is sent immediately to the system administrator as configured on the Smart-Vue Pro Duo/Quatro web platform.

Getting Started

Prerequisites for Getting Started

- One or both of the following:
 - LoRaWAN-enabled receiver installed and setup for web platform connectivity.
 - A smart-phone or tablet with bluetooth connectivity.
- 100-240 V AC power source and/or battery installed in data logger.
- Desktop or laptop with a supported web browser application (see **Smart-Vue Pro web application user documentation** for details).
- Internet access to smart-vuepro.thermoscientific.com for configuration.
- Smart-Vue Pro web account with at least one configured user.

Attach Antenna

The Smart-Vue Pro Duo/Quatro data logger requires an antenna to connect properly to your LoRaWAN network. The antenna is provided in the package with your data logger.

Attach the antenna to the data logger as shown here:

1. Place the antenna on the metal connector on the Smart-Vue Pro Duo/Quatro data logger.

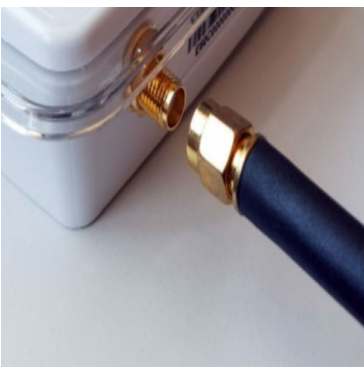

Figure 11. Place antenna on connector

2. Turn the ring clockwise and hand-tighten to attach the antenna firmly.



Figure 12. Turn ring to secure the antenna to the data logger

Activating the Smart-Vue Pro Duo/Quatro Data Logger for LoRaWAN

This section assumes that your Smart-Vue Pro LoRaWAN enabled receiver is up and running and within wireless range of the Smart-Vue Pro Duo/Quatro data logger you are trying to connect or that you have access to a carrier-operated Smart-Vue Pro LoRaWAN network.

To activate your Smart-Vue Pro Duo/Quatro data logger and enable it to communicate via the Smart-Vue Pro LoRaWAN network and the web platform. Lithium batteries are provided in the product box. Follow the steps:

1. Unscrew the screw behind the data logger.
2. Open the battery cover.

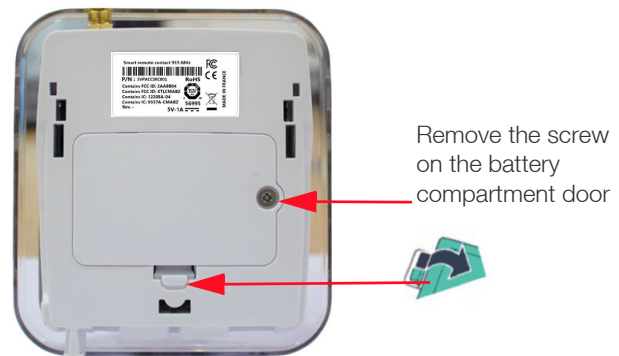

Figure 13. Removing the battery cover

3. Insert the provided batteries in the battery compartment, ensure polarity is checked (see printed image inside the compartment):

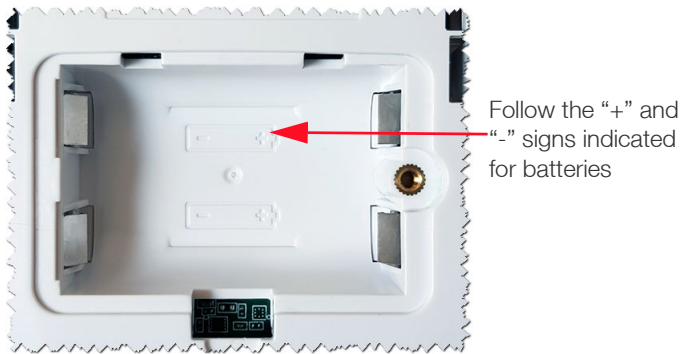

Figure 14. Ensure battery polarity indications inside battery cavity

4. Replace the battery compartment cover.
5. Do not over tighten the screw while replacing the cover.
6. Stand by during the boot sequence.
7. Once the boot is complete, select your region (for wireless use) and then setup, program and monitor your Smart-Vue Pro Duo/Quatro data logger as described in the Smart-Vue Pro web application documentation.

To power your data logger using the adapter:

1. Plug the AC adapter into the electrical power outlet.
2. Insert the adapter's cable into the USB port located on the side of the Smart-Vue Pro Duo/Quatro data logger, installing the 3.6 V batteries as a back-up.



CAUTION: Do not remove batteries from your data logger even while using the adapter. The batteries are also used as a backup for the AC adapter with the power supply switching automatically to the batteries in case of a power failure. You may change the batteries without losing any data as long as the AC adapter is plugged in. You may also change batteries one after the other to maintain power during the process.

Ready Screen/Regional Settings for Smart-Vue Pro LoRaWAN Frequency

This section assumes that your LoRaWAN-enabled receiver is up and running and within wireless range of the Smart-Vue Pro Duo/Quatro data logger you are trying to connect.

After you turn on the power of the Smart-Vue Pro Duo/Quatro data logger, specify your geographical region to determine the Smart-Vue Pro LoRaWAN frequency used for wireless communication. You cannot proceed beyond this screen unless you confirm your geographical location even if you only intend to use bluetooth connectivity.

Note: For a Smart-Vue Pro Duo/Quatro 868 MHz and 915 MHz modules shall show specific geographical location based on LoRaWAN frequency of the device.

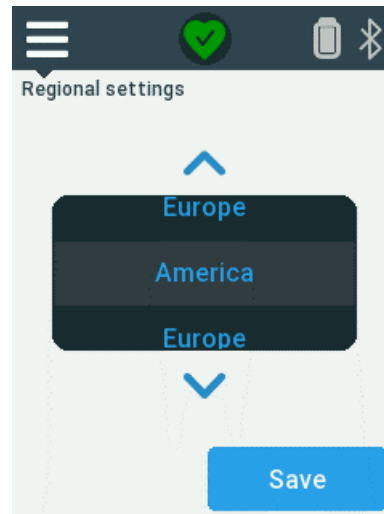

Figure 15. Select region to set the correct LoRaWAN frequency

1. Tap the up/down arrows (^ or v) to select your region (this only assigns the Smart-Vue Pro LoRaWAN radio frequency).
2. Tap **Save** to continue.
3. The Smart-Vue Pro ready screen is displayed showing waiting for configuration via the web or Smart Connect mobile application, depending on your needs. This screen is displayed whenever there is no active data logging session.

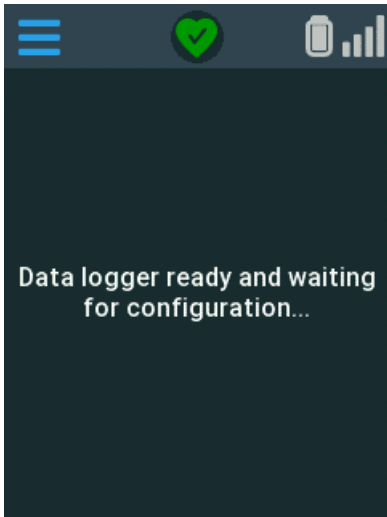

Figure 16. Smart-Vue Pro ready screen



Note: If you are using your data logger with Smart-Vue Pro LoRaWAN connectivity, you must use the **Smart-Vue Pro web application** to configure and start data logging and interact with your Smart-Vue Pro Duo/Quatro data logger.



Note: If you are using your data logger with bluetooth connectivity, you must use the **Smart Connect mobile application** to configure and start data logging and interact with your Smart-Vue Pro Duo/Quatro data logger.

Installing the Smart-Vue Pro Duo/Quatro Data Logger

Optimizing Wireless Performance

General Recommendations

For optimal performance, follow these recommendations when physically placing your Smart-Vue Pro Duo/Quatro data logger:

- The minimum distance between two data loggers must be 40 cm (16 inches).
- Make sure the data logger is not placed on an electrical conduit or cable tray (such as those used for computer network cables).
- Keep about 20 cm (8 inches) of clear space around the data logger. For example, a data logger that is “stuck” between two refrigerators may not communicate effectively.

Make sure all cables, if any, are firmly attached and sensors are properly inserted in the appropriate space being monitored.

Smart-Vue Pro LoRaWAN

A typical Smart-Vue Pro LoRaWAN wireless installation involves one or more Smart-Vue Pro Duo/Quatro data loggers and a Smart-Vue Pro LoRaWAN-enabled receiver. The Smart-Vue Pro LoRaWAN enabled receiver must be up and running and within wireless range of the Smart-Vue Pro Duo/Quatro data loggers you are trying to connect.

If necessary, see the **Smart-Vue Pro LoRaWAN-enabled receiver document** for requirements and details on the receiver component.

Long-range wireless connectivity enables Smart-Vue Pro Duo/Quatro data loggers to be placed nearly anywhere in your building or site. If you are using a Smart-Vue Pro LoRaWAN-enabled receiver and the signal is not strong enough, a second Smart-Vue Pro LoRaWAN-enabled receiver may be required. Contact authorized customer support team for support if you are having issues with connectivity.

- For best results, place the data logger facing the direction of the receiver (i.e. antenna vertical and not laying down on a table).

Bluetooth

As Bluetooth wireless technology is used to provide “short-range” connectivity (up to about 50 meters line-of-sight), it is important to keep the unit as clear as possible from surrounding obstruction.

Preparing the Mounting Kit

The Smart-Vue Pro Duo/Quatro data logger can be mounted easily on various surfaces. The data logger holder can be fixed using the screws or maintained in a stable position with its magnetic surface.

The holder enables you to quickly place the data logger or remove it for maintenance operations. For example, to change the batteries or clean the device.

Preparing the Mounting Kit

1. Attach the data logger holder to the desired location using the provided screws or adhere the magnet behind the holder to a metal surface. For best wireless performance, follow Thermo Scientific recommendations described in **Installing the Smart-Vue Pro Duo/Quatro Data Logger**.
2. Slide the data logger into the holder:



Figure 17. Slide the data logger

3. To prevent data logger removal, you may attach the device to the holder using the optional padlock:



Figure 18. Optional Padlock



CAUTION: It is not necessary to use the security padlock when wall-mounting the data logger.

4. To remove the data logger from the holder, proceed in the reverse order.

Using External Sensors

Pt100 Smart-Sensors

The following image shows a Smart-Vue Pro Duo/Quatro data logger with an external Pt100 sensor connected via the specially designed smart-sensor interface.



Figure 19. Smart-Vue Pro Duo/Quatro wireless data logger with a Pt100 Smart-Sensor

Connecting Smart-Sensors

The Smart-Vue Pro Duo/Quatro data logger and external Pt100 Smart-Sensors (and dual temperature/humidity sensors) are independent from each other while calibrating. Calibrated external Smart-Sensors store their own calibration parameters internally and can thus be plugged into any Smart-Vue Pro Duo/Quatro data logger.

Smart-Vue Pro Duo/Quatro data loggers support a specially designed Smart-Sensor technology which offers several key advantages of conventional solutions:

- Calibration correction parameters are stored directly in the Smart-Sensor where all sensor readings are adjusted for maximum accuracy.
- It is a simple plug and play functionality with no special configuration or manual update required.
- Data loggers and sensors are independent. Any supported sensor can be used with any Smart-Vue Pro Duo/Quatro data logger. This simplifies repairs, swap/exchange operations and calibration procedures.



CAUTION: You may swap a sensor while data logging is running only if you replace the first sensor with an identical type of sensor. The data logging session continues uninterrupted (unless you swap sensors at the exact moment the sensor is read, in which case you will see a “Sensor fail” error for a condition that is strictly temporary; see **Appendix 2 - Troubleshooting** for more details).

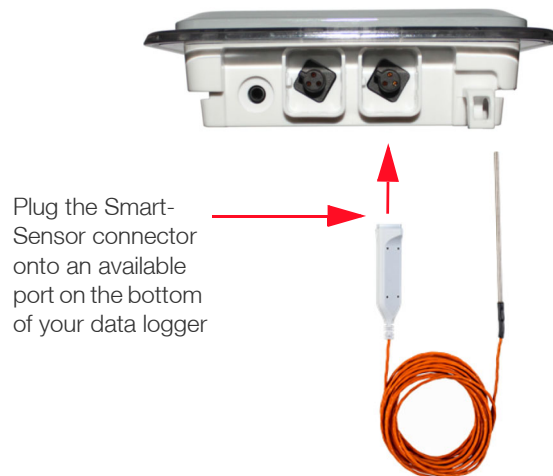

Plug the Smart-Sensor connector onto an available port on the bottom of your data logger

Figure 20. Connecting an external Pt100 sensor



CAUTION: This feature offers an easy way to handle sensors at calibration time (depending on your standard operating procedure) without leaving your equipment unattended. Keep an identical calibrated sensor ready to swap it with the one that needs calibration (replace with the same type of sensor: Pt100 with Pt100 or digital sensor with digital sensor).

Placing Smart-Sensors

Given the extreme temperature ranges typically handled by Pt100 sensors, ensure to use the Pt100 compatible mounting system provided with your freezer, oven, nitrogen tank or other equipment.

The Smart-View Pro wireless monitoring system supports different Pt100 temperature sensors, each one designed for a different application and temperature range. Placement of your Pt100 sensor(s) depends on the equipment you intend to monitor. Non-exhaustive guidelines are provided in the following sections.



CAUTION: In all cases described in this section, the plastic connector joining the data logger and the sensor must be in the same temperature space as the data logger, not the sensor.



CAUTION: When routing any sensor cable, avoid direct cable contact with or close proximity to, any high voltage wiring. Cabling should be placed at least 5 cm (about 2 inches) from any high voltage components. Avoid running the sensor cable parallel to high voltage wiring.

Your equipment may be different than the description. Contact the equipment manufacturer for instructions regarding proper sensor placement.

Pt100 for Ultra-Low-Temperature Freezers

Proceed with a thawed freezer while installing a Pt100 sensor in an ultra-low-temperature (ULT) freezer.

Route the sensor through the same access port used by the unit control sensor or an accessory port when required, as shown in **Figure 21**.

It is recommend to install the sensor only after the freezer has reached a thawed state while routing the Pt100 sensor through the same port used by the control sensor.

To negate the possibility of condensation dripping onto electronic components, avoid routing the cable in close proximity to any electrical enclosures.

Mount the Pt100 sensor as close to the unit control sensor as possible. It is recommend to mount the sensor within 5 cm (2 inches) of the control sensor.

Avoid placing it in direct contact with the freezer wall while mounting the Pt100 sensor. This will ensure the sensor is mounted to permit measurement of air temperature only.



CAUTION: It is not recommended to install the sensor through the door gasket on a ULT freezer. This leads to excessive ice build-up and possible door damage as well as longer compressor run times that may result in other mechanical problems.

The Pt100 which supports temperatures from $-200\text{ }^{\circ}\text{C}$ to $+50\text{ }^{\circ}\text{C}$ may be placed inside the freezer. Make sure you attach the sensor using the provided cable-ties and reseal any openings you may have unsealed to insert the sensor using Pergamum sealant.

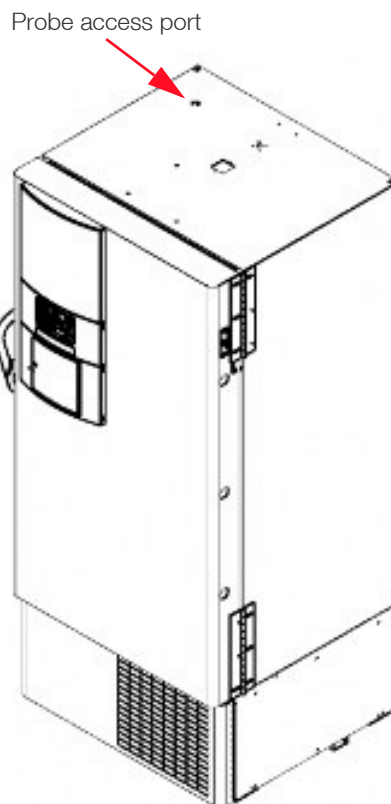

Figure 21. Sample Pt100 ($-100\text{ }^{\circ}\text{C}$ to $+150\text{ }^{\circ}\text{C}$) for ULT freezer

Pt100 for Liquid Nitrogen and Cryogenic Tanks

Pt100 sensors for LN_2 /cryogenic tanks must be mounted in close proximity to the unit display sensor, whenever it is applicable.

To avoid temperature measurement disparities, Thermo Scientific recommends mounting the sensor at the same height as the display sensor.

For example, some freezers have an access panel behind the unit in which you may route the sensor cable up the back wall. Place the cable under the tank gasket utilizing the notch at the 12 o'clock position. It is recommend to install Pergamum sealant where the cable passes through the notch.

Depending on whether storing in a vapor or liquid phase, place the sensor at a depth suitable for proper temperature monitoring.



Figure 22. Pt100 (-200 °C to + 50 °C) for nitrogen/cryogenic tank

Digital Temperature Sensors

Thermo Scientific external digital sensors do not connect to data loggers via the smart-sensor interface which means calibration parameters needs to be configured manually.



Note: Use the Smart-Vue Pro web application which loads the parameters onto the data logger over the network.



Note: Use the Smart Connect mobile application which loads the parameters onto the data logger directly via bluetooth.

Depending on the design of the space to be monitored, you may pass the sensor through an access port or opening. We recommend that you use the access port or opening.

1. During installation, while routing the sensor cabling through an access port or opening, connect the male end of the sensor firmly into the female end of the Smart-Vue Pro Duo/Quatro data logger.
2. Connect the male end of the sensor into the female end of the flat cable by joining the connectors (without unscrewing them) when installation requires passage through the door gasket seal. Then, connect the other end of the flat cable into the end of the Smart-Vue Pro Duo/Quatro wireless data loggers.



Figure 23. Smart-Vue Pro Duo/Quatro data logger with external digital sensor

Connecting a Digital Sensor

Connect the sensor cable to the data logger by plugging it in directly, as shown here:



Figure 24. Smart-Vue Pro Duo/Quatro data logger with external digital sensor

^ v

Placing the Sensor

1. If you have a Smart-Vue Pro Duo/Quatro data logger with one or more external sensors, the best solution is to use your equipment’s access port or specific opening to insert the sensor(s). Otherwise, run the temperature sensor into the enclosure via the door joint to place the flat cable flush with the joint.



CAUTION: Installation through the door gasket on freezers may cause ice build-up inside the freezer and/or on the freezer door. This may result in damage to the freezer door if not maintained. When used with incubators, a flat cable may cause condensation which could potentially increase the risk of contamination.

2. Clean the surface of the sensor using alcohol to remove grease or dirt.
3. Attach one of a plastic cable holders to the sensor, remove the protective strip from the adhesive and place the holder on the clean spot inside the enclosure.

4. Place the sensor / flat ribbon cable connector inside the chamber as shown in the following figure:



Figure 25. Sensor inside refrigerator chamber (data loggers with external sensor only)

5. Mounting kit includes a plastic holder that can be mounted using the provided magnet or screws. Choose the method which is most appropriate for your situation and place the Smart-Vue Pro Duo/Quatro data logger as described in **Installing the Smart-Vue Pro Duo/Quatro Data Logger**. For example:



Figure 26. Smart-Vue Pro Duo/Quatro data logger mounted on the refrigerator door

6. Attach or coil the excess cable neatly.

Temperature/Humidity Smart-Sensors™

The Smart-Vue Pro wireless humidity/temperature sensor monitors relative humidity levels and temperature. This option is generally used in various types of storage, medical and traceability applications.

This sensor connects via the Thermo Scientific Smart-Sensor connector and therefore already contains calibration parameters if the sensor was calibrated by Smart-Vue Pro.



Figure 27. Dual temperature-humidity sensor

Placing the Sensor

Mount the Smart-Vue Pro Duo/Quatro data logger in the desired location using the holder provided. Choose the attachment method that works best for your situation and place the Smart-Vue Pro Duo/Quatro data logger as described in **Installing the Smart-Vue Pro Duo/Quatro Data Logger**. Use the plastic cable holders provided to attach or coil the excess cable neatly.



CAUTION: When routing the cable for the Smart-Vue Pro Duo/Quatro sensor, avoid direct contact with or close proximity placement of the sensor cabling with any high voltage wiring. Cabling should be placed with not less than a minimum of 5 cm (2 inches) distance from high voltage components. Also, avoid running the sensor cable parallel to high voltage wiring.

CAUTION: Contact the manufacturer of the equipment for instructions regarding proper placement of the sensor.

Dry Contact Input Sensor

Overview

The dry contact input sensor on the Smart-Vue Pro Duo / Quatro data logger (requires firmware version 2.6.x or later) can be used to monitor many types of standard industry equipment that either provides a dry contact output connection or a simple pair of wires to form a continuous low-current electrical loop.

Typical applications include monitoring door opening-closing, uninterruptable power supplies, air conditioning units, and other laboratory equipment with remote contact capability



Figure 28. Smart-Vue Pro Duo/Quatro with dry contact input cable

The data logger can be configured to detect either a “normally closed” or “normally open” state to correspond with the device or equipment to be monitored.

Key Specifications

- 2-wire cable with 2.5 mm jack
- Cable length: 290 cm (114 inches)

Note: Memory capacity for the dry contact sensor channel is 2,000 readings.

Plugging the Connector Cable into your Data Logger

Start by connecting the dry contact connector cable into the input jack on your Smart-Vue Pro Duo/Quatro data logger.

1. Insert the jack into the hole on the bottom left-hand side of the data logger.

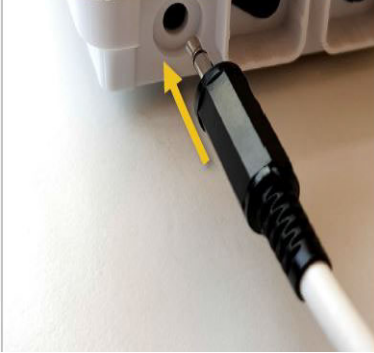

Figure 29. Insert jack into dry contact input plug

2. Ensure the jack is firmly in place before continuing.



Figure 30. Cable inserted into input jack on data logger

Activating Dry Contact Functionality

By default, the dry contact input sensor is not enabled on your data logger. Follow these steps to activate it:

1. Tap Menu (☰) → Sensors → Dry contact.
2. Enter your PIN code and tap OK.
3. Tap Configure.

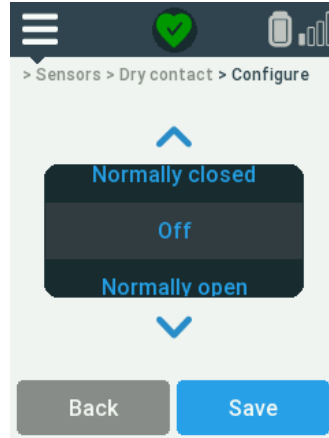

Figure 31. Dry contact settings

4. Tap the up/down arrows (or) to select Normally open or Normally closed.

Select normally open or closed as described below in **Wiring and Common Use Cases**.

5. Tap Save to confirm your choice.

Testing Current Status of Dry Contact Loop

After activating the dry contact input, you may check its current status as follows:

1. Tap Menu (☰) → Sensors → Dry contact.
2. Enter your PIN code and tap OK.

Tap Current status. If the two wires are not touching each other (or are connected to an open loop), this status is displayed:

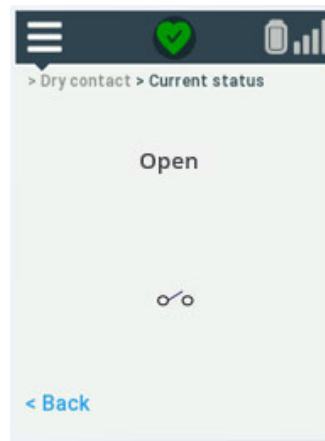

Figure 32. Dry contact loop is open

If the two wires are touching each other (or are connected to a closed loop), this status is displayed:

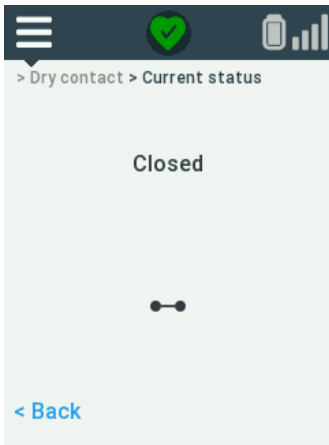

Figure 33. Dry contact loop is closed

3. Tap Back to exit this function.

Showing Sensors

You may confirm sensor configuration with respect to “Normally closed” or “Normally open”, typically after connecting the sensor to the output terminal or wires on the monitored device.

1. Tap Menu (☰) → Sensors → Show sensors.
2. If the loop is currently in its normal state, the sensor information screen shows “Normal”.

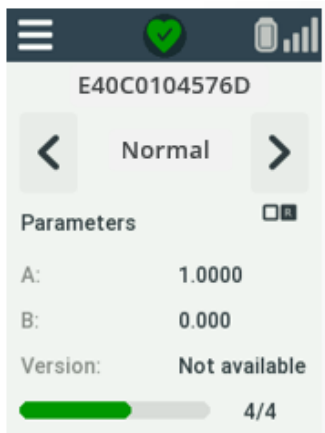

Figure 34. Dry contact loop showing Normal status

3. If the loop is not currently in its normal state, the sensor information screen shows “Triggered”.

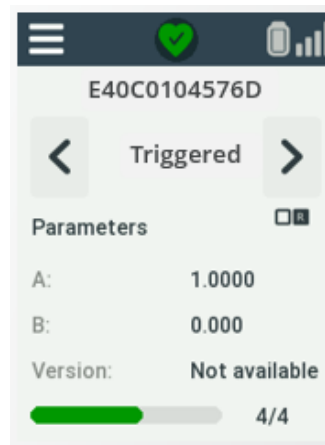

Figure 35. Dry contact loop showing triggered dry contact (not normal state)

Wiring and Common Use Cases

Connect the 2-wire cable from the Smart-Vue Pro Duo/Quatro module to the appropriate output or wiring on the device for which you are monitoring open/closed status.



CAUTION: The data logger implements a “dry loop”, that is, you must not inject any current or apply any voltage source to the dry contact wires.

CAUTION: The minimum state change detection time is about one second.

Normally Open” vs. “Normally Closed

It is important to establish whether your connected device or equipment is configured as “normally closed” or “normally open”.

Normally closed Status is considered normal if the loop is detected as “closed”



Figure 36. Electrical representation of closed loop

Normally open Status is considered normal if the loop is detected as “open”



Figure 37. Electrical representation of open loop



CAUTION: The Smart-Vue Pro Duo / Quatro data logger maintains a low charge on the current loop to detect when the loop is open or closed. For a device that is “normally open”, a status change is detected if the loop closes. You may configure an alert to be sent in that case. However, if the connecting cable or circuit is physically cut in a “normally open” configuration, the loop remains open and is considered to still be in the “normally open” state and no alert is sent. Industry applications are generally configured as “normally closed” for this reason.

Remote Alarm Contacts on Laboratory Equipment

The dry contact input sensor is commonly used to monitor laboratory equipment, such as ultra-low-temperature freezers with a specific remote alarm contact output terminal. The contacts, which are triggered in the event of various alarm conditions, are typically located on the back of the equipment.

The diagrams below show the two configuration options for this type of situation:

Table 4. Wiring and configuration from a dry contact output terminal

Terminal connection options	Corresponding Smart-Vue Pro Duo/Quatro setting:

It does not matter which color wire you connect to the terminal plugs.

Wired Door Contact

The dry contact input sensor is well suited for monitoring door contact devices. In this case, “Normally closed” is the most common setting (that is, the door is considered to be closed under normal circumstances).

2 wire connection	Corresponding Smart-Vue Pro Duo / Quatro

It does not matter which color sensor input wire you connect to the data logger’s two wires.



CAUTION: It is important to note that you may not change the configuration from “Normally closed” to “Normally open”, or vice versa, while data logging is running. You must first stop data logging in Smart-Vue Pro web application.

4-20 mA and 0-5 V Loop Sensors

Description

4-20 mA current loop and 0-5 V current Smart-Sensors can be connected to industry-standard devices that generate appropriate output signal. The signal can be measured to provide status information for a variety of applications, including wind monitors, particle counters, ultra-low-temperature (ULT) freezers, and temperature, gas, VOC, and relative humidity devices, and more. Read values are converted into useful information by the Smart-Vue Pro web application, then displayed both in the web application and on the Smart-Vue Pro Duo / Quatro data logger display.



Figure 38. 4-20 mA / 0-5 V Smart-Sensor

Sensor wiring:

Black	Common ground
Red	0-5 V input
White	4-20 mA input

Connect the wires according the type of device you want to monitor.



CAUTION: The maximum voltage on the 4-20 mA input wire is 2 V. Exceeding that value will damage your sensor.

Smart-Vue Pro Duo / Quatro User Interface

The Smart-Vue Pro Duo/Quatro data logger offers a highly visible color LCD screen and a simple menu system. You can easily navigate through data logging pages and menu settings using the data logger's touch screen even while wearing protective gloves.

Using the Touchscreen



CAUTION: The Smart-Vue Pro Duo/Quatro touchscreen responds to a light touch from your finger. Do not use excessive force or sharp objects when pressing the touch screen or you may damage your data logger.

Table 5. Using the touchscreen

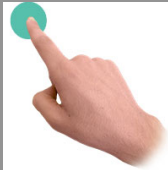
Action	Description	Gesture
Tap to activate	Briefly touch the Smart-Vue Pro Duo/Quatro screen surface with your fingertip to select a menu item, press a button or enter your PIN code using the on-screen keypad.	

Entering your PIN Code

Some actions on your Smart-Vue Pro Duo/Quatro data logger requires you to enter a PIN code to continue.

The PIN code is contained in the user's profile on the Smart-Vue Pro Duo/Quatro web application. You can choose 4 digits of the PIN code and the system adds 2 digits to create a unique 6-digit PIN code.

Enter the PIN code when prompted by the data logger display. Tap OK to continue.

Note: Before the device is setup in Smart-Vue Pro web application, the default pin code 000000 shall be used to access the password protected screens.

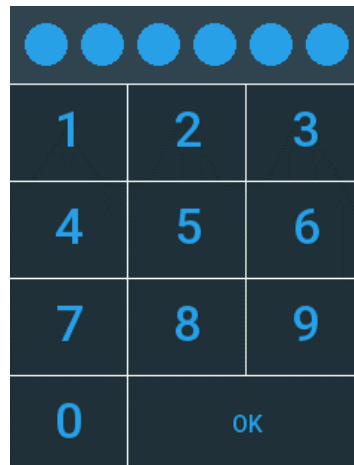

Figure 39. PIN code keypad

Sensor Display and Control

The Smart-Vue Pro Duo/Quatro features connectors which can be configured to meet your needs. You may monitor up-to two physical parameters simultaneously (2 channels) with the Duo data logger. You may monitor up to four physical parameters simultaneously with the Quatro data logger.



Note: The Smart-Vue Pro Duo/Quatro mobile application – Smart Connect – only supports one active temperature sensor if the unit is used in bluetooth-only mode.

The data logger automatically adjusts the display of readings and events based on the number of connected sensors. The Smart-Vue Pro Duo/Quatro screen splits into distinct areas to simultaneously display the latest temperature readings, minimum and maximum values and alarm status as appropriate.

The bar at the top of the screen shows status icons and useful reference information as explained in the following sections.

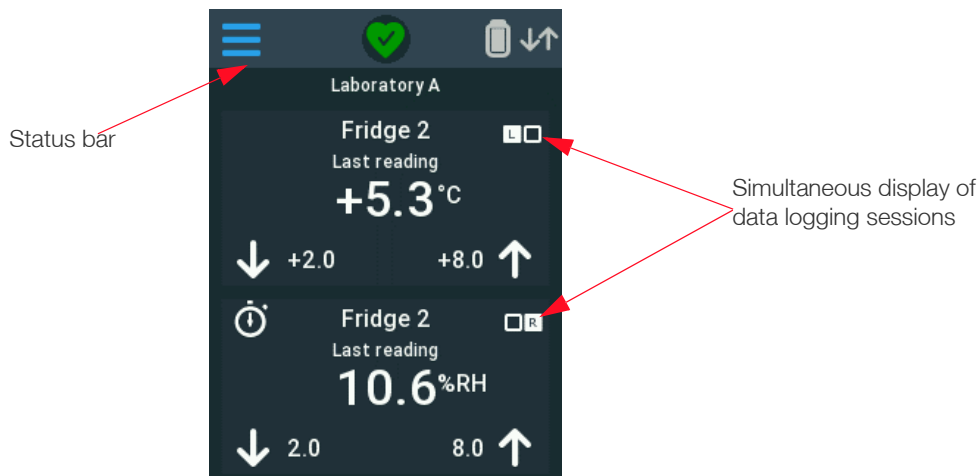

Figure 40. Smart-Vue Pro Duo/Quatro with two data logging sessions in progress

Status Bar

The Status bar across the top of Smart-Vue Pro Duo/Quatro screen includes the menu icon and shows wireless status, battery status and the data logger name. The status bar remains visible on all screens except when the device is in screen saver mode. It is slightly different in Smart-Vue Pro LoRaWAN and bluetooth modes.

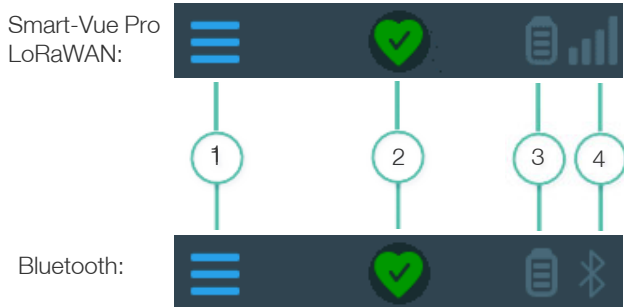









Figure 41. Smart-Vue Pro status bar

Gesture	Description
	Opens the menu.
	Indicates that there are no alarms in any of the data logging sessions currently running on the data logger.
	If any alarms are detected, the icon turns red.
	Battery level indicator displays the power level of the Smart-Vue Pro Duo/Quatro.
	Smart-Vue Pro LoRaWAN network status: Indicates wireless network status with signal strength bars (4 bars for best signal, 1 bar if signal is weak).
	A warning triangle is displayed if the data logger is disconnected from the wireless network.
	Indicates that the data logger is in bluetooth-only mode. Smart-Vue Pro LoRaWAN connectivity is turned off.

Data Logging

The Smart-Vue Pro Duo/Quatro data logger shows the currently programmed data logging cycle(s). Data is shown on a single screen or splits into distinct areas when two or more configurations are defined.

Single Data Logging Session (one sensor)

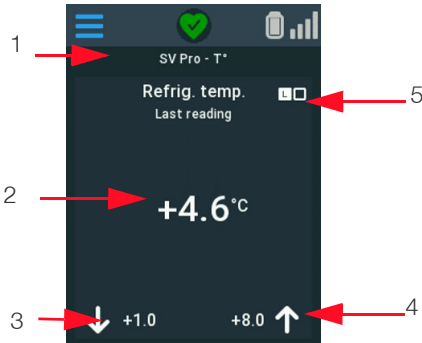

Figure 42. One active data logging session

The Smart-Vue Pro Duo/Quatro display always shows the key information about the sensor:

1. Data logger name
2. Last-read value
3. Programmed low limit (if applicable)
4. Programmed high limit (if applicable)
5. Indicates on which plug the sensor is connected (left or right position on Smart-Vue Pro Duo/Quatro data loggers).

Two Data Logging Sessions (two sensors)

The display can show details for up to two sensors at the same time:



Figure 43. Two active data logging sessions

6. Latest reading for both sensors

More than two data logging sessions (three or four sensors)

When data logging is active for three sensors, arrows show at the bottom of the screen to access the next page:

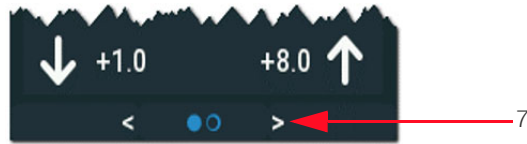

Figure 44. Screen with more than two active data logging sessions

7. Switches to the next data logging screen (and by sliding to left or right, next data logging screens).



Note: When using LoRaWAN connectivity the Smart-Vue Pro Duo/Quatro data logger reads its sensor(s) and transfers data wirelessly to the Smart-Vue Pro web platform at regular intervals, configured via the Smart-Vue Pro web application. Data transmission to the web platform occurs periodically but not every time sensors are ready (unless an alarm occurs, in which case the alarm is raised immediately). If you change data logging settings in the web application, the values on the Smart-Vue Pro Duo/Quatro screen are updated when the next transfer interval occurs.



Note: With bluetooth connectivity, the Smart Connect mobile application handles data transfer and data logger configuration which loads the parameters onto the data logger directly via bluetooth.

Instant Reading

Data on the Smart-Vue Pro screen is refreshed periodically. As a result, the temperature in the monitored environment may be different than the current reading displayed on the unit itself. You may check the current reading at any time without affecting stored information.

To perform an instant reading

1. Tap the current sensor value on the screen.
2. The current sensor reading is displayed as “Instant reading” for a few seconds, then returns to the regular screen.

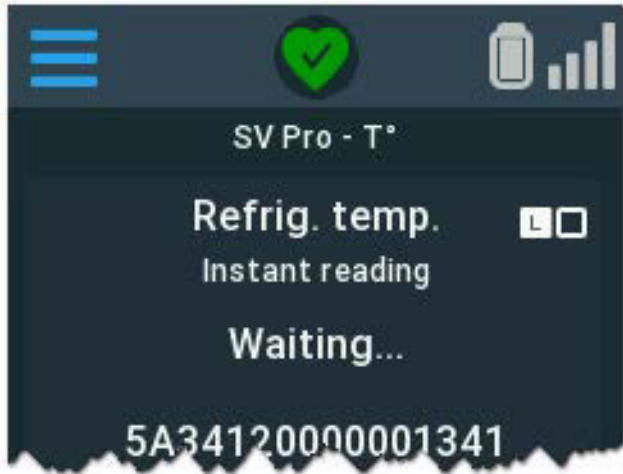

Figure 45. Tap for instant reading without affecting saved data



CAUTION: Instant reading is for your information only and is not stored in the database.

Screen Backlight

When the Smart-Vue Pro Duo/Quatro is on battery power, the backlight is managed to preserve battery life. The backlight turns off after 30 seconds of inactivity following the last user action.

When the display is turned off, touch the Smart-Vue Pro Duo/Quatro screen to turn it back on. By default, the screen backlight remains on when the device is plugged in using the AC power adapter (USB).



CAUTION: If the screen does not turn on when you touch it, it is possible that the batteries are low but the data logger is still functioning. In this case, it is advised to plug in the AC adapter and replace the batteries.

Screen Saver

The Smart-Vue Pro Duo/Quatro data logger also features a screen saver that is enabled when the device is using AC power (via the USB charger) and there are no alarms in progress.

After 30 seconds of inactivity, the Smart-Vue Pro Duo/Quatro screen turns dark and the screen saver shows the sensor name and the last temperature reading. This information scrolls around the Smart-Vue Pro Duo/Quatro screen until you tap the screen.

If the device is connected to several sensors, the text switches to the next sensor every 10 seconds. Tap the screen to activate your Smart-Vue Pro Duo/Quatro data logger.

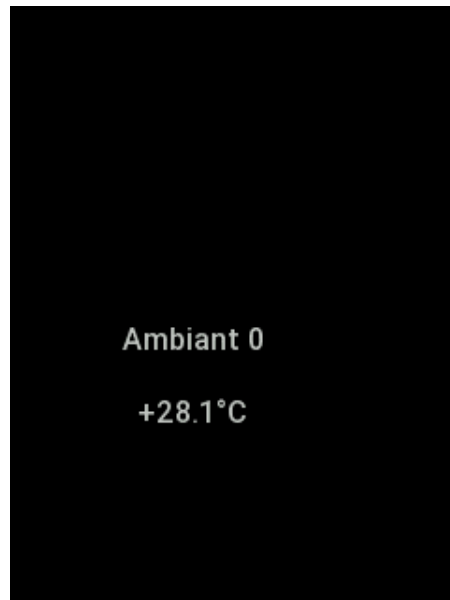

Figure 46. Smart-Vue Pro Duo/Quatro display with active screen saver

Configuration Menus

The Smart-Vue Pro Duo/Quatro data logger includes configuration menus to interact with the data logger and setting specific parameters.

Tap the menu bars to open configuration menus.



Figure 47. Accessing Smart-Vue Pro Duo/Quatro configuration menus

The following diagrams shows the menu structure according to whether the data logger is being used with Smart-Vue Pro LoRaWAN or bluetooth wireless communication. Features are described in the following sections:

Menu structure of data logger using Smart-Vue Pro LoRaWAN

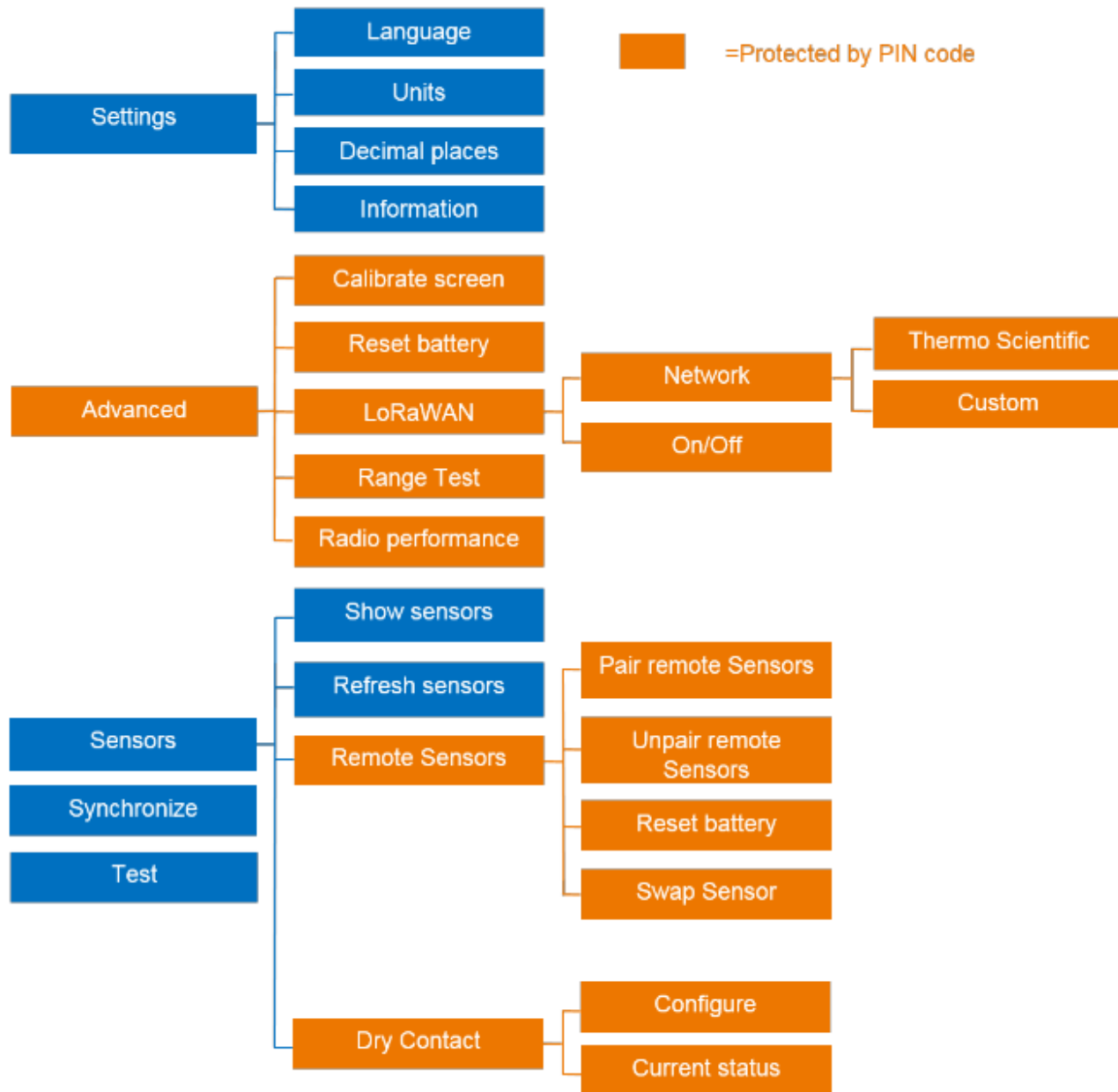

Figure 48. Menu structure for Smart-Vue Pro LoRaWAN wireless operation

Menu structure of data logger using Bluetooth

The structure is the same as for Smart-Vue Pro LoRaWAN operation, but some options that are not available in bluetooth mode are grayed out.

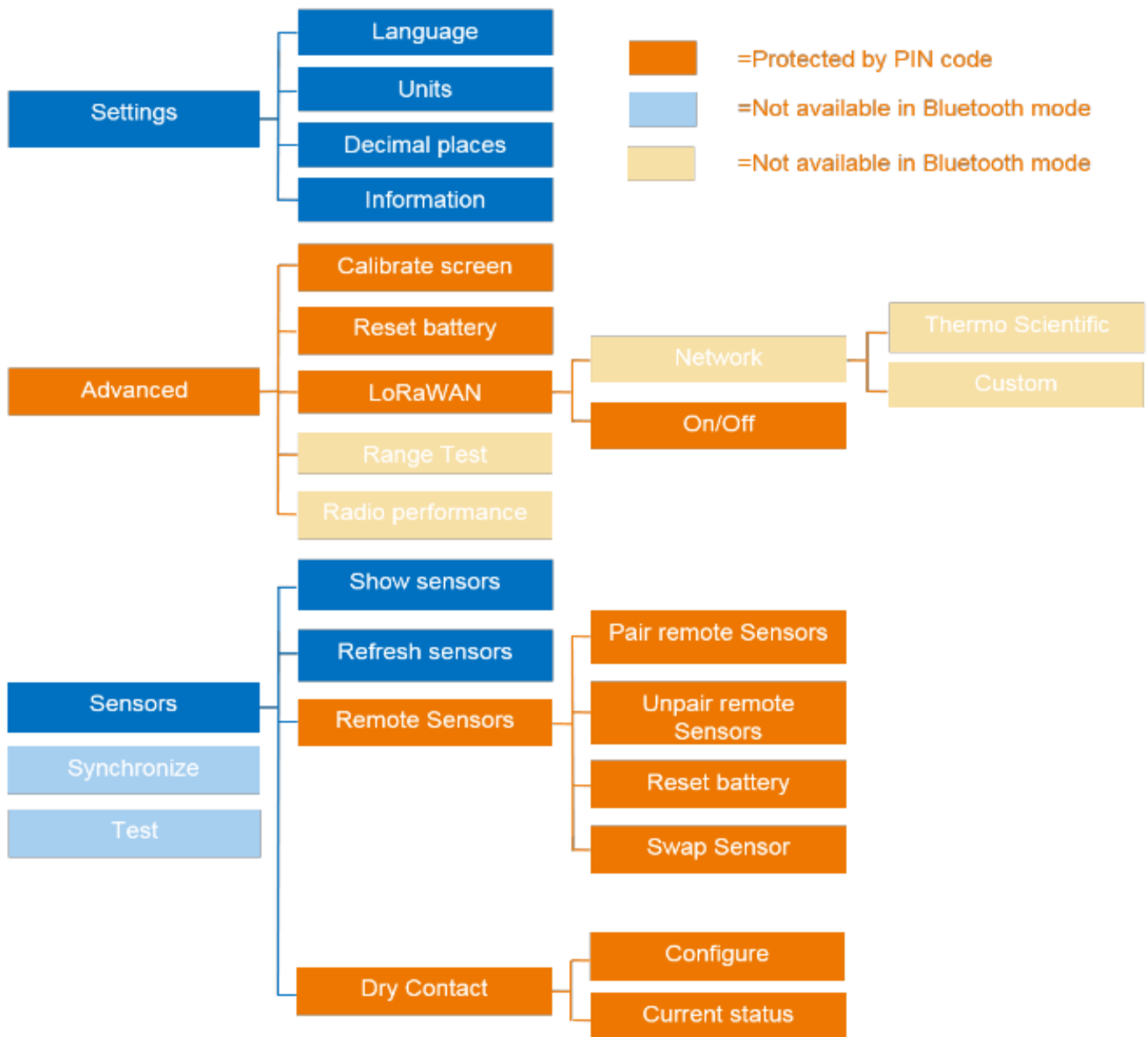

Figure 49. Menu structure for Bluetooth wireless operation

Settings

The settings menu contains the following options:

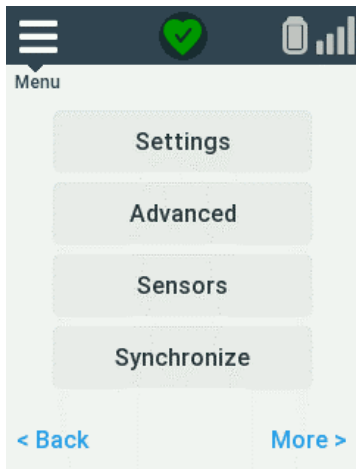

Figure 50. Options in the Settings menu

Setting Smart-Vue Pro Duo/Quatro Language

The **Language** option allows you to change the display language of your Smart-Vue Pro Duo/Quatro.



CAUTION: This language setting does not affect the regional setting you chose when you turn on the power of the data logger (see **Ready Screen/Regional Settings for Smart-Vue Pro LoRaWAN Frequency**).

To change the language:

1. Tap the menu icon (☰) → **Settings** → **Language**.

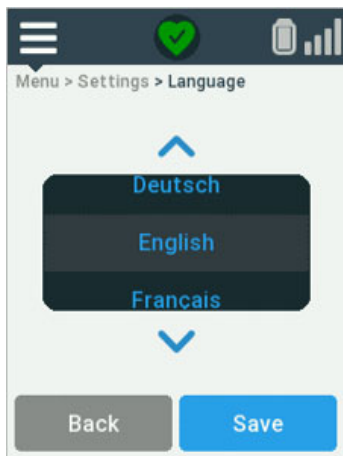

Figure 51. Choosing display language

2. Tap the up/down arrows (▲ or ▼) to select the display language.
3. Tap **Save** to confirm the selected language and return to the previous menu.
4. Tap the menu icon (☰) to return to the home screen.

Changing the Temperature Unit

Temperature readings are either displayed in degrees Celsius (°C) or Fahrenheit (°F). To change the temperature unit shown on your Smart-Vue Pro data logger:

1. Tap the menu icon (☰) → **Settings** → **Units**.
2. Tap the up/down arrows (▲ or ▼) to select the desired unit.



Figure 52. Choosing temperature unit (°C or °F)

3. Tap **Save** to confirm the selected unit and return to the previous menu.
4. Tap the menu icon (☰) to return to the home screen.

Decimal Places

You may choose to display sensor readings on the home screen with either one or two decimal places as shown here:

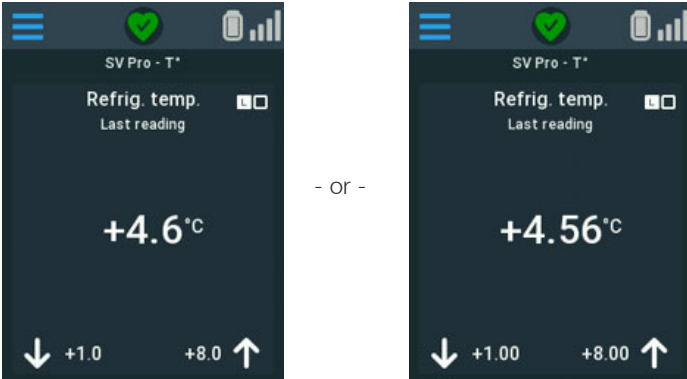

Figure 53. Values displayed with one or two decimal points

1. Tap the menu icon (☰) → **Settings** → **Decimal places**.

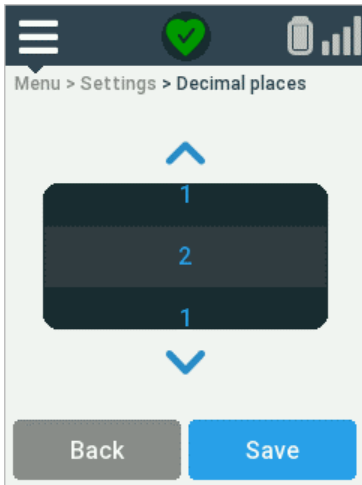

Figure 54. Choosing one or two decimal points to display values

2. Tap the up/down arrows (▲ or ▼) to select the desired number of decimal places.
3. Tap **Save** to confirm the selected unit and return to the previous menu.
4. Tap the menu icon (☰) to return to the home screen.

Information

System information such as the firmware version, Smart-Vue Pro LoRaWAN wireless frequency and remaining battery capacity can be found in the information screen.

This information is useful in case you need technical support and are asked to provide specific details.

1. Tap the menu icon (☰) → **Settings** → **Information**.
2. Tap **Settings** → **Information**.

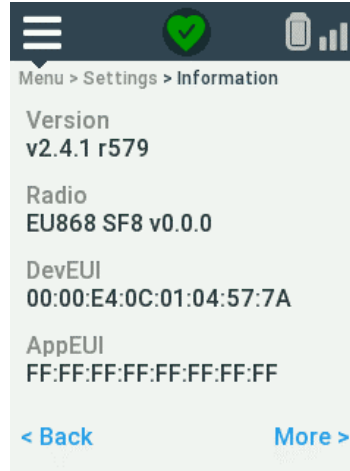

Figure 55. Accessing detailed device information

3. Tap the more button to access the next menu page.
4. Tap the menu icon (☰) to return to the home screen.

Sensors

Showing Sensors

When several sensors are connected to your Smart-Vue Pro Duo/Quatro data logger, you may display the readings and parameters of each sensor using the Show sensors feature. The display shows each sensor for approximately 10 seconds before cycling on to the next.

Tap the menu icon (☰) → **Sensors** → **Show sensors**.

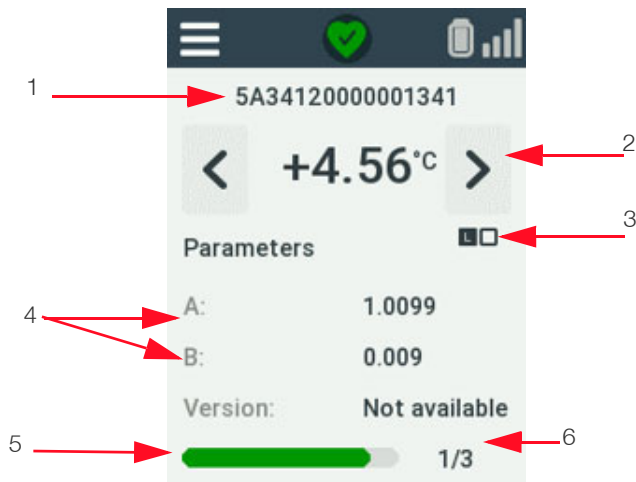

Figure 56. Sensor information

The following sensor information is displayed on the screen:

1. Sensor serial number
2. Last-read value
3. Physical position of the sensor on your data logger (left or right connector on Smart-Vue Pro Quatro devices only).
4. Sensor calibration parameters
5. Progress bar shows how long the screen will be shown before displaying the next sensor.
6. Counter shows total number of sensors and current sensor.

The screen returns to the **Sensors** menu once the display has cycled through all sensors. You may interrupt the process at any time by tapping the menu icon (☰).

Updating Sensors on Smart-Vue Pro Duo/Quatro

When you physically plug a sensor into the Smart-Vue Pro connector, the data logger automatically recognizes the sensor and sensor type. The information is then transmitted to the Smart-Vue Web application. If a sensor is not present or not up to date in the web application, you may use the Refresh sensor option to force detect the new sensor and update the configuration.

To update sensors in Smart-Vue Pro:

1. Tap the menu icon (☰) → **Sensors** → **Refresh sensors**. The system updates data in Smart-Vue Pro Duo/Quatro.
2. When the process is complete, a confirmation message is shown on the screen.

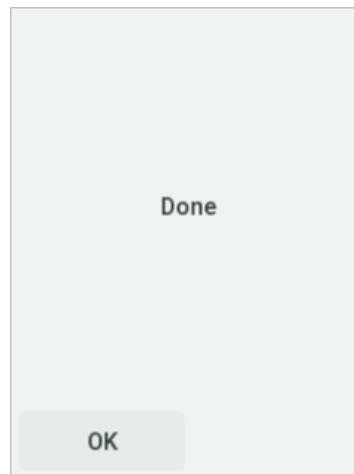

Figure 57. Confirmation that sensors are updated on the web application

3. Tap **OK** → menu icon (☰) to return to the home screen (otherwise the display returns automatically to the Sensor menu after about 5 seconds).

Swapping Sensors

With your Smart-Vue Pro Duo/Quatro data logger, you may directly swap wired sensors that are physically connected to your data logger, such as recalibration or to replace damaged cables. Wired sensors may be replaced on-the-fly whether data logging is running or not. Ensure that you replace the sensor with the identical type of sensor. The process is completely transparent and guarantees continuity while avoiding down-time or interruptions.

Advanced Menu

The Smart-Vue Pro Duo/Quatro data logger includes an Advanced menu that you can use for troubleshooting and to confirm that your data logger is working properly.

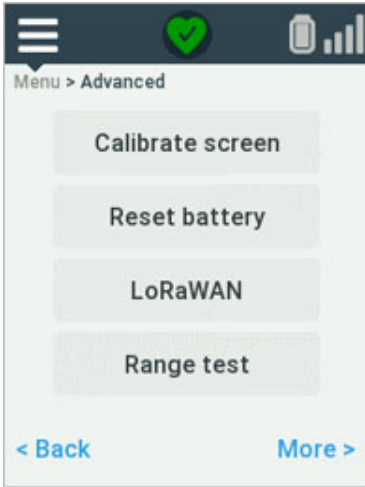

Figure 58. Features in the Advanced menu

To limit access to the Smart-Vue Pro parameters and prevent unwanted changes, the **Advanced** menu is protected by a personal access code and recommended for qualified personnel only. Enter your PIN code and tap **OK** to continue. Contact your system administrator if you do not know your code or if you have forgotten it.



CAUTION: Features in the **Advanced** menu should be used only when needed and by qualified technicians.

Calibrating the Smart-Vue Pro Screen

If your Smart-Vue Pro Duo/Quatro data logger screen does not respond accurately to your touch, the touch screen may require calibration to position touch point coordinates correctly.

Proceed as follows to calibrate screen alignment:

1. Tap the menu icon (☰) → **Advanced**.
2. Enter your PIN code and tap **OK**.
3. Tap **Calibrate screen** and follow the instructions on the screen. Starting in the upper-left corner, press and hold your finger on the screen – or use a pencil eraser to touch the edges more easily. Continue to press the screen, slide around the edges to all four corners of the screen, as shown on the image below:

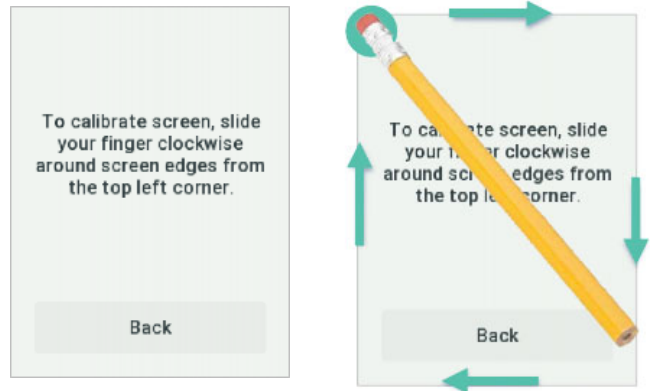

Figure 59. Slide your finger or an eraser around the screen for best touch accuracy

After you pass through each calibration point sequentially, the screen returns to the **Advanced** menu.

Resetting the Smart-Vue Pro Duo/Quatro Battery Counter

It is imperative to replace Smart-Vue Pro Duo/Quatro data logger batteries when the battery indicator is down to one bar, before data logging becomes unreliable. To install new batteries, see **Replacing Batteries**.

After replacing batteries, you must reset the battery counter so that your data logger displays the correct battery status.



CAUTION: This function should only be used if you replace your data logger's batteries with reliably new batteries.

To reset the battery counter:

1. Tap the menu icon **Advanced**.
2. Enter your PIN code and tap **OK**.
3. Tap **Reset battery** → **OK** to continue.
4. Tap **OK** → menu icon (☰) to return to the home screen.
5. The battery icon in the status bar should show a full battery, with all three bars.



Figure 60. Battery counter showing 100% change

Smart-Vue Pro LoRaWAN Network Setup

Smart-Vue Pro LoRaWAN wireless technology offers the flexibility to deploy your Smart-Vue Pro solution with different types of access architecture. Your network selection must reflect the license or subscription you choose for your system.

Thermo Scientific: With this option, a Smart-Vue Pro LoRaWAN wireless receiver is installed at your site and connects to the Smart-Vue Pro web platform hosted by secure web services. Data loggers communicate with the receiver to exchange data with the Smart-Vue Pro web application and services.

Custom: Choose this option if your solution uses an entirely on-premises network. That is, the Smart-Vue web platform is installed on a server that is managed by your IT department. The server may be a local server at your site or a server hosted on your own web platform services. Two options are identical in terms of configuration, even if the physical architecture is different.

To configure your data logger:

1. Tap the menu icon (☰) → **Advanced**.
2. Enter your PIN code and tap **Smart-Vue Pro LoRaWAN** → **Network**.

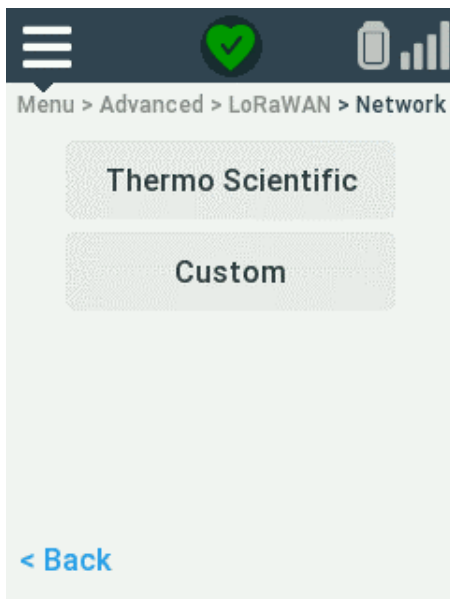

Figure 61. Smart-Vue Pro LoRaWAN network options

3. Tap to select the desired installation type (see definitions above):

Thermo Scientific: Select your region to determine the proper radio frequency to use. Click **Save**.

Custom: Select your region to determine the proper radio frequency to use. Enter the installation code provided to you when you purchased your license. Click **Save**.

Checking Smart-Vue Pro LoRaWAN Wireless Communication Quality

You may use the range test feature in the **Advanced** menu to ensure that your Smart-Vue Pro Duo/Quattro data loggers are within wireless range of the configured Smart-Vue Pro LoRaWAN network (i.e. your own Smart-Vue Pro LoRaWAN receiver or an operator's network). This feature is useful for system installers, as helps you prepare an environment before deploying Smart-Vue Pro Duo/Quattro data loggers.

Confirming signal quality also allows you to identify optimal locations for your data loggers within the wireless coverage area.



CAUTION: This section assumes that your Smart-Vue Pro LoRaWAN-enabled receiver is installed, configured and running or that your facilities are covered by an operator's network. This test also performs an end-to-end test of the Smart-Vue Pro solution and verifies the connection to the server.

To test your Smart-Vue Pro LoRaWAN wireless coverage

1. Tap the menu icon (☰) → **Advanced**.
2. Enter your PIN code and tap **OK** → **Range test**
3. Tap **test** on the displayed screen.
4. The system performs a series of wireless communications test (notably using "spreading factor modulation") to determine wireless signal quality. If reception is strong, the result is indicated in green; if it is not strong enough, the result is indicated in red.

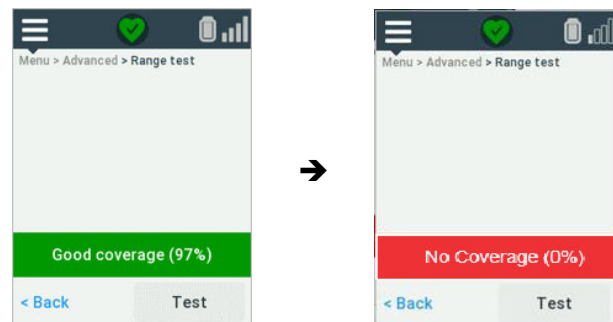

Figure 62. Smart-Vue Pro LoRaWAN wireless coverage test

CAUTION: We recommend not setting up your devices if signal level is weak. Poor signal quality can result in inadequate coverage and cause system performance or reliability problems.



CAUTION: The wireless signal may be affected by excessive obstruction, RF/radio interference, or harsh environmental conditions. Make sure the data logger in question is placed optimally long-term operation.

CAUTION: Contact support services if you are having difficulties connecting to the Smart-Vue Pro LoRaWAN network.

5. Tap the menu icon (☰) when you are done with this test.

LoRaWAN Radio Performance

You may check to see how well your data logger's wireless radio is performing. Based on results, you may choose to adjust placement or positioning of the data logger.

1. Tap the menu (☰) → **Advanced**.
2. Enter your PIN code and tap OK → More Radio → Performance → Test.

	GW	Dev
RSSI	-100	-200
SNR	-2	-1

Figure 63. LoRaWAN radio performance test

In this screen:

RSSI	Received Signal Strength Indicator: [Min: -140 / Max: -20] This is for information only. Generally speaking, the higher the value the better.
SNR	Signal-to-Noise ratio: [Min: -20 / Max: +20] A positive SNR value indicates a strong transmission. The transmission is less strong as the number descends. Generally speaking, SNR values down to -10 are acceptable.
GW	Gateway: Indicates the values received by the gateway from the data logger.
Dev	Data logger: Indicates the values received by the data logger from the gateway.

Quick Server Connection Test

You may use the **Test** command to make sure that your Smart-Vue Pro Duo/Quatro is able to communicate with the server without entering the **Advanced** menu (as described above). This function sends a request to the server and waits for a response to determine whether the server is responding as required.

To test communication with Smart-Vue Pro LoRaWAN network:

1. Tap the menu icon (☰) → **More**.

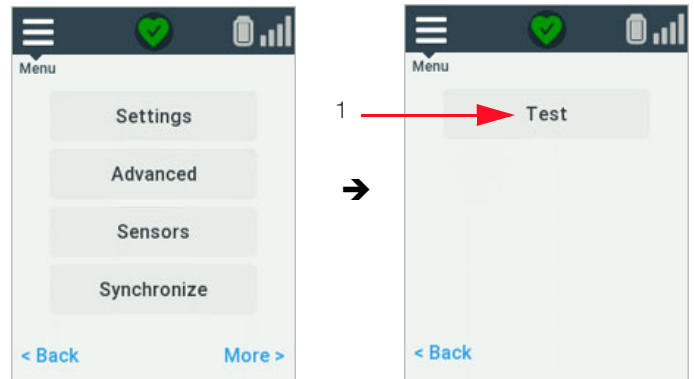

Figure 64. Quick server connection test

2. Tap **Test (1)**.
3. Stand by while the system tries to reach the server.

Results are displayed on the screen as shown here:



Figure 65. Server connection test results

There are only two possible results: Test successful or Test failed. This information can help you troubleshoot data logger problems. If the test fails, it indicates that the outside network cannot be reached from either your Smart-Vue Pro Duo/Quatro data logger or your local Smart-Vue Pro LoRaWAN receiver. If you are using a local receiver, check the internet connection and check installation. Contact Thermo scientific technical support if you are unable to resolve the problem on your own.

4. Tap the menu icon (☰) to return to the home screen.

Data Synchronization

The Smart-Vue Pro Duo/Quatro solution allows you to force synchronize your Smart-Vue Pro Duo/Quatro data logger with the server. This may be useful to speed up certain operations notably:

- When adding a new sensor to a Smart-Vue Pro data logger: the **Synchronize** function, updates the new sensor on the server right away, otherwise the update occurs at the next programmed data transfer.
- If you make data logging configuration changes on the server, using the **Synchronize** function on the data logger causes the changes to be taken into account right away.
- You can also use this option to send the latest mission data on-demand without waiting for the transfer interval (this refreshes the information for the web application display but does not affect data logging graphs and records).

To synchronize your data logger data:

1. Tap the menu icon (☰) → **Synchronize**.
2. If the data logger's network connection is up and running (which you can test as described in the previous section), information is updated bidirectionally.
3. Tap the menu icon (☰) to return to the home screen.

Using the Data Logger in Bluetooth-only Mode

The Smart-Vue Pro Duo/Quatro data logger may be used in “Bluetooth-only” mode, that is, without any LoRaWAN functionality. The data logger can be accessed using the Smart Connect mobile application for smart-phones and tablets.

This operating mode is described in detail in **LoRaWAN vs Bluetooth Wireless Topologies**.

To deactivate Smart-Vue Pro LoRaWAN and use your data logger in Bluetooth-only mode:

1. Make sure that data logging is not currently running on the device.
2. Tap the menu icon (☰) → **Advanced**.
3. Enter your PIN code → tap **OK** → **Smart-Vue Pro LoRaWAN** → **On/Off**.
4. Tap the up/down arrows (▲ or ▼) to select **On** or **Off**.
5. Tap **Save** to apply the change or **Behind** or the menu icon (☰) to cancel.
6. If you turn off Smart-Vue Pro LoRaWAN, Bluetooth is the only active wireless communication as indicated in the upper right-hand corner of the display.

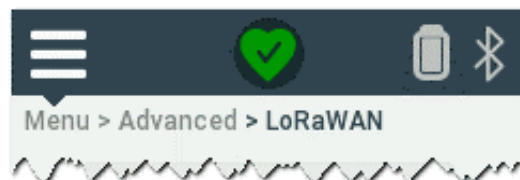

Figure 66. Bluetooth icon in status bar

Alarm Management

An alarm is an indication of an abnormal condition or problem detected by your system.

When your system detects an alarm, whether a limit alarm or a technical alarm such as a communication problem or sensor disconnection, the translucent outer ring around the Smart-Vue Pro casing flashes for as long as data logger remains in an alarm condition.



CAUTION: Regardless of data transfer interval, alarms are always transmitted to the server immediately upon detection.

When the sensor value returns to its normal range or when the user has manually acknowledged the alarm, the Smart-Vue Pro Duo/Quatro is displayed with its default background theme.



CAUTION: If you have subscribed to the Smart-Vue Alert solution, you will also be notified via SMS/text message or voice call in case of alarms. Contact the sales representative for more details.



Figure 67. Data logger with alarm condition indicated by red LED

The alarm is also shown in red on the data logger display, for example:

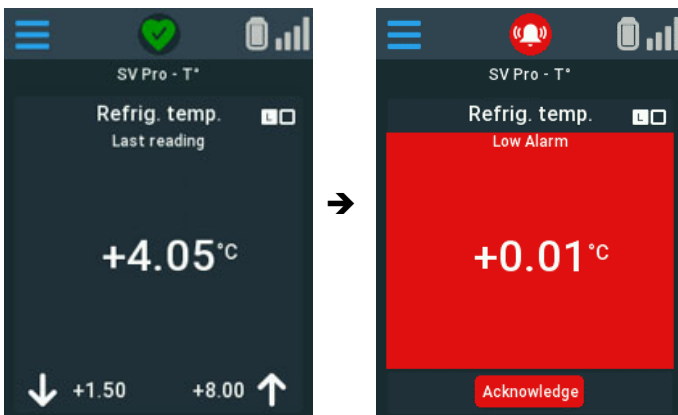

Figure 68. Data logger with alarm condition indicated on data logger screen

LED Status Indications

The color LED on the Smart-Vue Pro casing indicates data logger status and offers simple patterns based on status, as described below:

Table 6. LED status indication

General	(● = short flash)
Data logger is booting	● ● ●
Bluetooth connected	● ● ●● (every 6 seconds)
After Bluetooth disconnection	● (every 10 seconds for 1 minute)
Data logging status	(● fixed for 1 second)
Alarm in progress	●



CAUTION: When the Smart-Vue Pro Duo/Quatro data logger is running on batteries, the outer ring will continue flashing in case of an alarm, even if the data logger screen has gone dark. In that case, tap to wake up the screen and handle the alarm as described in the following sections.

Alarm Actions

When the Smart-Vue Pro Duo/Quatro data logger is running on external power (using the provided AC adapter), the data logger's buzzer is activated to notify users in case of event on the device or at any point during data logging. For example, the buzzer is heard when the temperature or humidity is above or below programmed limits.



CAUTION: To preserve data logger battery life, the buzzer is not activated when the data logger is running on batteries.

Snoozing an Alarm

If an alarm condition is encountered and the buzzer is activated, the Smart-Vue Pro Duo/Quatro display shows an alarm icon (bell) at the top of the data logging screen:

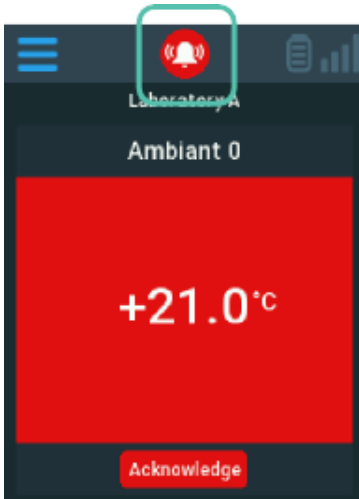

Figure 69. Bell icon indicating that alarm sound is active

In some cases, or certain known situations, you may want to mute alarms temporarily.

To snooze an alarm:

1. Tap the alarm icon **(1)** once.
2. A “mute” symbol appears in the left-hand corner of the screen:



Figure 70. Bell icon indicating that alarm sound is active

3. The alarm sound is silenced for one hour. If alarm condition is still present, the alarm sound automatically plays again.
4. Even if an audio alarm is cleared, a visual alarm remains on the Smart-Vue Pro screen as long as the alarm condition is still present.



CAUTION: The Smart-Vue Pro web application provides access to measurements and alarms recorded by data loggers.

Acknowledging an Alarm

When an alarm is in progress the Smart-Vue Pro Duo/Quatro data logger remains in an alarm state as long as the alarm conditions are present.

If data logging was programmed with a delay to trigger an alarm only after a specified period of time, a stopwatch icon is displayed on the data logging screen (as described in the next section) and the alarm is activated when the limit is reached.

It is important for you to acknowledge data logger alarms and take care of any problems so that further alarms do not continue to occur. The problem may persist even if you have acknowledged the alarm on the Smart-Vue Pro Duo/Quatro display.

CAUTION: Acknowledging alarms requires specific permissions. Only authorized users with appropriate rights and access codes can acknowledge alarms.



CAUTION: The web application interface is updated when you acknowledge an alarm on the data logger screen. However, if you acknowledge the alarm only in the web application, the data logger will still show the alarm indication.

Alarm Delay Indicator

You may program a delay before the alarm is triggered while setting up data logging. For example, you could set a 5 minutes delay for the data logger, where its value is the multiple of read interval. As per the delay set data logger to wait before triggering an alarm in case the temp rises above the programmed limit

In that case, if a reading on your Smart-Vue Pro Duo/Quatro data logger goes over a programmed limit value, a stopwatch **(1)** is displayed in the upper left-hand corner to indicate that the data logger is in a “pre-alarm” state.

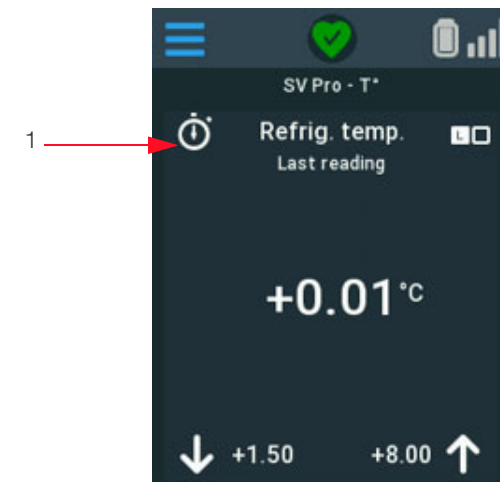

Figure 73. Pre-alarm indicator on data logger display



CAUTION: The presence of the stopwatch icon indicates that the data logger has encountered an alarm condition but that the end of time delay has not yet reached.

To acknowledge alarms:

1. Tap the **Acknowledge** button **(1)**.

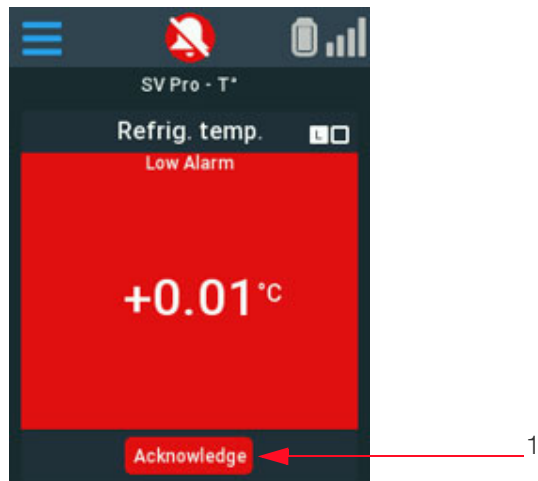

Figure 71. Tap Acknowledge button to clear alarm

2. Enter your PIN code and tap **OK**.
3. Tap the up/down arrows (▲ or ▼) to select a reason for the acknowledgment.

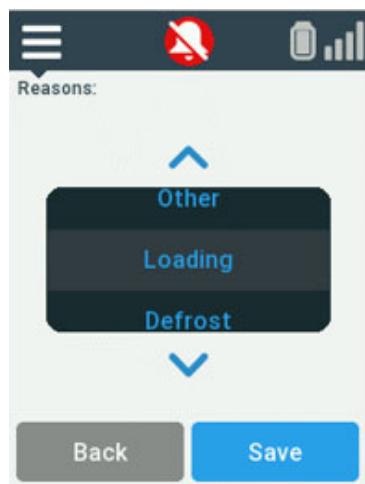

Figure 72. Choose a reason for acknowledging the alarm

4. Once the alarm is acknowledged, the alarm icon is no longer shown (alarm icon is displayed as crossed bell) on the Smart-Vue Pro Duo/Quatro data logger screen. The alarm status is also updated in the Smart-Vue Pro web application.

Maintaining your Data Loggers

Replacing Batteries

The Smart-Vue Pro Duo/Quatro data logger runs on batteries and/or AC power (via an adapter plugged into the USB port). Batteries are not installed prior to delivery.



CAUTION: Data in data logger memory is lost if you remove both batteries. If data logging is currently running, do not remove both batteries at the same time. A single battery is sufficient to maintain power during the change.

We recommend plugging the Smart-Vue Pro Duo/Quatro data logger into AC (USB) power when changing batteries to avoid any risk of data loss.

To replace batteries:



CAUTION: When replacing the batteries, ensure both the batteries are replaced with **NEW** batteries.

Follow the below sequence to replace with new batteries and ensure that the battery counter is reset by pressing Reset Battery in SVP Quatro Menu. See **Resetting the Smart-Vue Pro Duo/Quatro Battery Counter**.

Note: The battery indication does not provide the battery level from the actual battery. There is no electronic component in the data logger that measures the battery level from the actual battery. The battery indication displayed is the battery level which is calculated by the data logger software based on usage and has a dependency on the battery counter reset.

Note: Battery Reset is performed by the user when they replace new batteries in the Smart-Vue Pro Duo/Quatro and Battery Reset must be performed only when replacing old battery by new battery. When the battery counter is reset, it is assumed that a new battery is used which implies a 100% full battery. If this step is not performed correctly or if the battery is defective, then the battery counter may be invalid.

1. Remove the data logger from its mounting bracket if necessary. If possible, keep the device plugged into the AC (USB) power source.



Figure 74. Optional: plug data logger into AC (USB) power to avoid losing data

2. Use a manual screwdriver to remove the screw from the battery cover on the back of the data logger by turning the screw counterclockwise (1), then push the plastic tab open and remove the battery cover.

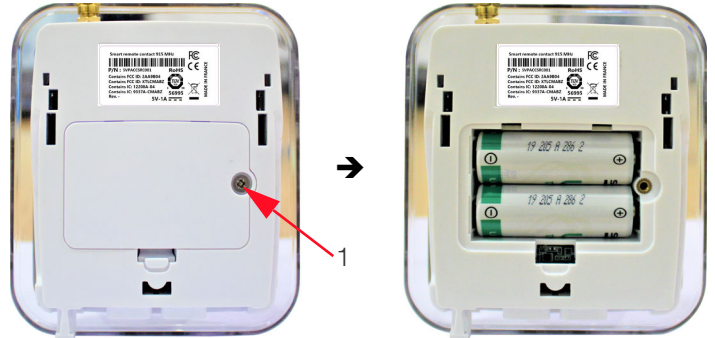

Figure 75. Remove battery cover

3. A single battery will ensure continued operation so you can replace the other battery without interrupting data logging:

- Remove one used battery from the data logger and replace it with a new one, making to respect battery polarity (see image printed inside battery slot).

- With the first new battery firmly in place, remove and replace the second used battery.



Figure 76. Replace one battery after the other (and/or keep AC power on)



CAUTION: If you remove both batteries simultaneously, the data logger will shut down and data logging currently in progress will be stopped (readings in memory are not lost).

4. Clip the battery compartment cover back onto the unit and replace the screw being careful not to over-tighten it.
5. Wait during the boot sequence.



CAUTION: After replacing batteries, the battery counter must be reset to recognize the new battery status. See **Resetting the Smart-Vue Pro Duo/Quatro Battery Counter**.

Cleaning Instructions

You may occasionally need to clean your Smart-Vue Pro Duo/Quatro data loggers depending on conditions at your site.

Here are some recommendations and guidelines for cleaning your data loggers:

1. Clean the data logger using a soft cloth lightly moistened with water, a detergent or isopropanol alcohol.
2. Do not use any aggressive cleaning agents or scratching cleansers that might damage your data logger.
3. Do not submerge the data logger in any liquid, as the casing is not waterproof.

Appendix 1 – Smart-Vue Pro Duo/Quatro Battery Life

Smart-Vue Pro Duo/Quatro data logger battery life varies depending upon many factors:

1. **Ambient temperature:** Battery capacity is diminished when subject to very cold or extreme heat conditions.
2. **Wireless communication:** Smart-Vue Pro LoRaWAN and Bluetooth wireless communication consumes battery power. Therefore, battery life depends on factors such as the connection frequency and signal quality.
3. **Screen backlight:** The backlight is activated each time you press the Smart-Vue Pro Duo/Quatro screen but also when the data logger enters into an alarm condition. Extended use of the screen backlight reduces battery life considerably when the data logger is running on battery power.
4. **Alarm indicator (LED):** When the system triggers an alarm, the outer ring around the Smart-Vue pro Duo/Quatro casing flashes as long as your data logger remains in an alarm condition. Prolonged use of the LED consumes power and reduces the data logger's battery life.
5. **Wireless sensors:** When using Smart-Vue Pro Duo/Quatro with compatible wireless sensors, Bluetooth communication consumes battery power. The more wireless sensors used, the higher the battery consumption on the Smart-Vue Pro Duo/Quatro data logger.



CAUTION: These considerations do not apply when using Smart-Vue Pro Duo/Quatro on AC (USB) power.

Estimated Battery Life

The estimated Smart-Vue Pro Duo/Quatro operating lifetime on batteries is about 2 years, based on:

- Starting with new batteries.
- A Smart-Vue Pro Duo/Quatro data logger equipped with 1 digital sensor and 1 Pt100 sensor.
- 1 reading every 10 minutes.
- Smart-Vue Pro LoRaWAN wireless transmission every 20 minutes.
- 1 touchscreen press per day.

Appendix 2 - Troubleshooting

If you are having difficulties with your configuration, refer to the frequently asked questions before contacting technical support.

I swapped a sensor and received a Sensor Fail error. But then everything seemed OK. What happened?

Most likely, you performed the swap as the sensor was being read by the device. This generates an alarm concerning that precise moment. If the new sensor is working correctly, the problem can be considered as being very temporary and you can simply acknowledge the alarm to close it.

The Smart-Vue Pro Duo/Quattro data logger screen is black. When I tap the screen, nothing is displayed and there does not seem to be any reaction. What should I do?

Is your data logger running on battery only?

If so, the batteries might be low and the screen is turned off because the data logger is in power saving mode. Try plugging in the AC (USB) power supply. If the screen comes back on then install fresh batteries (i.e. one after the other) and/or leave it plugged in.



CAUTION: Remember to use the “Reset battery” function when you install fresh batteries but never use that function unless you actually change the batteries.

Are the batteries inserted correctly?

First, make sure the batteries are installed and inserted in the right direction (+/- according to the image in the battery slot). Try testing the unit with batteries that are known to be of the correct size and voltage (3.6 V Lithium, 3600 mA). If the problem persists and the screen does not display anything, contact technical support.

The Smart-Vue Pro Duo/Quattro data logger is properly connected to the web platform. Why don't I get any temperature readings?

The Smart-Vue Pro wireless protocol is based on Smart-Vue Pro LoRaWAN technology. The data logger connects wirelessly to your Smart-Vue Pro LoRaWAN-enabled receiver and transfers data periodically but not at every reading. If you modify data logging settings in Smart-Vue Pro, the values on the Smart-Vue Pro Duo/Quattro screen will be updated when the next reading interval occurs. Wait for the next transfer interval to get your data updated.

This could also be due to a loose cable or improperly connected temperature sensor. Check the cable between the Smart-Vue Pro Duo/Quattro data logger and the sensor.

Unplug the sensor and plug it back in. Make sure there are no exposed wires. Try a different sensor.

Can external sensors be submerged in glycol?

Yes, for all metal-tipped sensors but not the dual temperature/humidity sensor (with the white Teflon/PTFE casing). To “absorb” sudden variations in temperature, such as those caused by opening and closing the chamber door, you may submerge the metal part of the sensor in glycol or glycerol. This limits inconsequential temperature variations recorded by the sensor. Check your laboratory’s quality guide for recommendations and make sure to use a volume of glycol that corresponds to the volume of product(s) you are monitoring. To achieve the same results, you may also delay the transmission of alarms via the software and leave the sensors exposed.

This page is
intentionally
left blank.

WEEE Compliance

WEEE Compliance. This product is required to comply with the European Union's Waste Electrical & Electronic Equipment (WEEE) Directive 2012/19/EU. It is marked with the following symbol. Thermo Fisher Scientific has contracted with one or more recycling/disposal companies in each EU Member State, and this product should be disposed of or recycled through them. Further information on our compliance with these Directives, the recyclers in your country, and information on Thermo Scientific products which may assist the detection of substances subject to the RoHS Directive are available at www.thermofisher.com/WEEERoHS under Services & Support.

Great Britain



WEEE Konformität. Dieses Produkt muss die EU Waste Electrical & Electronic Equipment (WEEE) Richtlinie 2012/19/EU erfüllen. Das Produkt ist durch folgendes Symbol gekennzeichnet. Thermo Fisher Scientific hat Vereinbarungen getroffen mit Verwertungs-/Entsorgungsanlagen in allen EU-Mitgliederstaaten und dieses Produkt muss durch diese Firmen wiederverwertet oder entsorgt werden. Mehr Informationen über die Einhaltung dieser Anweisungen durch Thermo Scientific, die Verwerter und Hinweise die Ihnen nützlich sein können, die Thermo Fisher Scientific Produkte zu identifizieren, die unter diese RoHS-Anweisung fallen, finden Sie unter www.thermofisher.com/WEEERoHS unter Services & Support.

Deutschland

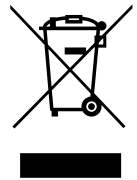

Conformità WEEE. Questo prodotto deve rispondere alla direttiva dell'Unione Europea 2012/19/EU in merito ai Rifiuti degli Apparecchi Elettrici ed Elettronici (WEEE). È marcato col seguente simbolo. Thermo Fisher Scientific ha stipulato contratti con una o diverse società di riciclaggio/smaltimento in ognuno degli Stati Membri Europei. Questo prodotto verrà smaltito o riciclato tramite queste medesime. Ulteriori informazioni sulla conformità di Thermo Fisher Scientific con queste Direttive, l'elenco delle ditte di riciclaggio nel Vostro paese e informazioni sui prodotti Thermo Scientific che possono essere utili alla rilevazione di sostanze soggette alla Direttiva RoHS sono disponibili sul sito www.thermofisher.com/WEEERoHS in Servizi e Supporto.

Italia



Conformité WEEE. Ce produit doit être conforme à la directive euro-péenne (2012/19/EU) des Déchets d'Equipements Electriques et Electroniques (DEEE). Il est marqué par le symbole suivant. Thermo Fisher Scientific s'est associé avec une ou plusieurs compagnies de recyclage dans chaque état membre de l'union européenne et ce produit devrait être collecté ou recyclé par celles-ci. Davantage d'informations sur la conformité de Thermo Fisher Scientific à ces directives, les recycleurs dans votre pays et les informations sur les produits Thermo Fisher Scientific qui peuvent aider la détection des substances sujettes à la directive RoHS sont disponibles sur www.thermofisher.com/WEEERoHS sous Services et Assistance.

France



Contact Information

Thermo Fisher Scientific products are backed by a global technical support team ready to support your applications. We offer cold storage accessories, including remote alarms, temperature recorders, and validation services.

Visit www.thermofisher.com or call:

Countries	Sales	Services
North America	+1 866 984 3766	(800) 438-4851
India	1800 22 8374, +91 22 6716 2200	+91 22 6716 2200
China	+800 810 5118, +400 650 5118	+8621 68654588
Japan	+81 3 5826 1616	+81 3 3816 3355
Australia	+61 39757 4300	1 300 735 292
Austria	+43 1 801 40 0	+43 1 801 40 0
Belgium	+32 53 73 42 41	+32 2 482 30 30
France	+33 2 2803 2180	+33 2 2803 2180
Germany	0800 1 536 376, +49 6184 90 6000	0800 1 536 376
Italy	+32 02 95059 552	+39 02 95059 552, 432 254 375
Netherlands	+31 76 579 55 55	+31 76 571 4440
Nordic/Baltic/CIS	+358 9 329 10200	+358 9 329 100
Russia	+7 812 703 4215	+7 812 703 4215
Spain/Portugal	+34 93 223 09 18	+34 93 223 09 18
Switzerland	+41 44 454 12 22	+41 44 454 12 12
UK/Ireland	+44 870 609 9203	+44 870 609 9203
New Zealand	+64 9 980 6700	+64 9 980 6700
Other Asian Countries	+852 2885 4613	+852 2885 4613
Countries not listed	+49 6184 90 6000	+49 6184 90 6000

Thermo Fisher Scientific Inc.
 275 Aiken Road
 Asheville, NC 28804
 United States

Find out more at thermofisher.com/cold